



**University  
of Victoria**

Facilities  
Management

# **Interior Wayfinding Signage and Safety and Information Signage**

## **Specifications and Details**

**CONTENTS**

<b>GENERAL REQUIREMENTS</b>	<b>3</b>
<b>MATERIAL LIST AND SPECIFICATIONS</b>	<b>11</b>
<b>DETAIL DRAWINGS</b>	<b>18</b>
<b>BUILDING DIRECTORIES [D SERIES]</b>	<b>19</b>
Building Directory [D1].....	19
Mini Building Directory [D2].....	20
<b>WAYFINDING / DIRECTIONS [W SERIES]</b>	<b>22</b>
Sub Directory [SD1, SD2, SD3] .....	22
Wall Mounted Wayfinding [W1] .....	26
Suspended Wayfinding [W2] .....	30
<b>AREA IDENTIFICATION [DEP SERIES]</b>	<b>33</b>
Department Identification Signs [DEP1, DEP2] .....	33
Department Identification Banner [DEP3].....	40
Hanging Department Identification Banner [DEP3a] .....	40
Hanging Department Service Sign [DEP4] .....	42
<b>ROOM IDENTIFICATION [ID SERIES]</b>	<b>44</b>
Room Number Door Plates [ID1].....	44
Office Information Signs [ID2, ID3, ID4] .....	48
Room Occupant Badges and Nameplates [ID5, ID6] .....	49
Occupancy Load Wall Plates [ID7] .....	51
Meeting Room Sleeves [ID8] .....	54
Room Number Sleeves [ID9].....	56
First Aid Door Signs [ID10] .....	60
Building Number Signs [ID11] .....	61
Door Information Plates [ID12] .....	62
Desktop Nameplate [ID14] .....	63
Freestanding Partition Nameplate [ID15] .....	64
Out of Office Signs [ID16] .....	65
Residence Whiteboard Door Signs [ID17] .....	70
Projecting Office Information Signs [PID1, PID2] .....	71
<b>WASHROOM IDENTIFICATION [WID SERIES]</b>	<b>73</b>
Door and Stall Signs [WID1-WID18].....	73
Washroom Backing Signs [WB1].....	82
Projecting Washroom Signs [P1-P11] .....	83
<b>ELEVATOR, STAIRWELL &amp; OTHER IDENTIFICATION &amp; PROJECTING [S &amp; P SERIES]</b>	<b>85</b>
Stairwell Signs [S1].....	85
Stairwell Wayfinding Sign .....	86
Stairwell / Elevator Graphic Signs [S3] .....	87
Stairwell Graphic Signs [S4] .....	88
Stairwell No Exit Signs [S5] .....	89
Stairwell No Storage Signs [S6] .....	90
Stairwell Roof Access Signs [S7] .....	91
Elevator In Case of Emergency Signs [S8] .....	92
Projecting Signs [P1 - P4].....	93

---

<b>DIGITAL SIGNAGE [M SERIES]</b>	<b>96</b>
Digital Signage [M1] .....	96
<b>SAFETY SIGNS AND NOTICES [N SERIES]</b>	<b>97</b>
Safety Signs [N1] .....	97
Notices [N2] .....	97
Wall Mounted Sign Holders [N3] .....	98
Lab Information Sign Holders [N4] .....	105
Joint Local Safety Committee Sign [N5] .....	107
<b>EVACUATION PLANS [E SERIES]</b>	<b>109</b>
Evacuation Plan Holder [E1] .....	109
<b>APPENDIX A - LOGOS AND TYPICAL DETAILS</b>	<b>A-1</b>
UVic Logo Elevation C .....	A-1
UVic Logo Elevation D .....	A-1
Typical Bevel Detail .....	A-1

**1.1 SUMMARY OF WORK**

1. This contract is for the creation of sign location plans & elevations, sign content databases and the fabrication, delivery to site and installation of interior wayfinding signage. This Interior Wayfinding Specification and Details document shall be read in conjunction with additional project specific documents, including:
  - .1 Asbestos handling procedures included as an Appendix to this document.
  - .2 UVic RFT document including bid form, instructions to bidders and general conditions.

**1.2 CONTRACT METHOD**

1. The Contract method for this work will be outlined in the UVic RFT document.

**1.3 PROJECT COORDINATION**

1. Coordinate progress of the work, including progress schedules, submittals, use of site, utilities and construction closures within building with Facilities Management.

**1.4 SCOPE OF WORK**

1. The physical scope of signage work shall be determined by owner and may consist of an area greater than the area of construction work.
2. Work performed shall include:
  1. Creating existing sign inventories
  2. Creating sign demolition plans
  3. Creating new & existing sign layout plans and elevations
  4. Creating sign naming databases

**1.5 PROCEDURES FOR FMGT PROJECTS TEAM & ARCHITECTURAL CONSULTANTS****1.6 SIGN INVENTORY**

1. Responsibility & Scope: The Consultant shall conduct a full inventory of existing signage, artwork and boards and all other peripheral items, i.e. sensors, fire alarms, room controls etc.
2. Approvals: The Consultant shall submit a plan to owner for verification and approval and shall resubmit as required.

**1.7 SIGN DEMOLITION PLANS**

1. Responsibility: Creating the sign demolition plans shall be the responsibility of the Consultant.



2. Scope: The Consultant shall work with owner to determine which signs, artwork, boards and other peripheral items to remove and relocate and shall create a plan that clearly identifies items to remain and items to be relocated and/or removed. It will also include instructions for patching and making good as required. This plan can be incorporated into new sign layout plans.
3. Approvals: The consultant shall submit a plan to owner for verification and approval and shall resubmit as required.

### **1.8 SIGN LAYOUT PLANS AND ELEVATIONS**

1. Responsibility: Creating sign layout plans and elevations shall be the responsibility of the Consultant.
2. Scope: The Consultant shall create plans and elevations that clearly identify the locations of new, existing and relocated signs. Elevations shall be provided for all affected walls and shall incorporate signs, architectural features, exposed mechanical and fire safety equipment, artwork, boards and nearby furniture that may affect the visibility or access to signage.
3. Approvals: The Consultant shall submit a plan to owner for verification and approval and shall resubmit as required.

### **1.9 SIGN DATABASE**

1. Responsibility: Creating sign databases shall be the responsibility of the Consultant. Owner shall provide information regarding official department names, room names and names and titles of occupants.
2. Scope: The Consultant shall create a sign database which clearly identifies floor levels, if signs are new or existing signs are updated, sign locations, room descriptions, sign types, arrow directions, full text on sign and on reverse side where applicable and notes regarding mounting and any additional information. The sign database will provide complete information to supplement information provided in sign location plans and elevations.
3. Approvals: The Consultant shall submit a plan to owner for verification and approval and shall resubmit as required.

### **1.10 CUTTING AND PATCHING**

1. Responsibility: Cutting and patching shall be located and paid for by the Contractor.
2. Approvals: Submit written request in advance of cutting or alteration which affects:
  - .1 Structural integrity of any element of the Project.
  - .2 Integrity of weather-exposed or moisture-resistant elements.
  - .3 Efficiency, maintenance, or safety of any operational element.

- .4 Visual qualities of sight-exposed elements.
- .5 Work of Owner or separate Contractor.
- .6 Disruption of other occupancies within the building.
3. Inspection:
  - .1 Inspect existing conditions, including elements subject to damage or movement during cutting and patching.
  - .2 After uncovering, inspect conditions affecting performance of Work.
  - .3 Beginning of cutting or patching means acceptance of existing conditions.
  - .4 Make Good, defined as matching adjacent surfaces such that there is no visible difference between existing and new surfaces when viewed in ambient light from a distance of 1500mm. In renovation areas, “make good” means repairing substrate surfaces and, in areas not scheduled for refinishing, refers to patching, repairing, and finishing to match adjacent surfaces and includes applying a new paint finish to surface up to the next change in plane in all directions.
4. Execution:
  - .1 Execute Work to avoid damage to other Work.
  - .2 Prepare proper surfaces to receive patching and finishing.
  - .3 Employ workers, experienced in the Work to be cut or patched to perform cutting and patching for weather-exposed and moisture-resistant elements, and sight-exposed surfaces.
  - .4 Cut rigid materials using power saw or core drill. Pneumatic or impact tools not allowed.
  - .5 Where alterations to existing surfaces are required, restore Work with new products and make good.
  - .6 Refinish surfaces to match adjacent finishes; for continuous surfaces refinish to nearest intersection; for an assembly, refinish entire unit.

### **1.5 SUBMITTALS**

1. Provide submittals listed for review with reasonable promptness and in an orderly sequence so as to not cause delay in the Work. Provide a schedule of submittals at commencement of the project.
2. Work affected by the submittal shall not proceed until review is complete.
3. Review submittals prior to submission to the Facilities Management. This review represents that necessary requirements have been determined and verified, or will be, and that each submittal has

been checked and coordinated with the requirements of the Work and the Contract Documents.

4. Verify field measurements and affected adjacent Work are coordinated.
5. Provide submittals as electronic copies from the Contractor to the Consultant and/or Facilities Management.
6. Provide Material Safety Data Sheets (MSDA) to Facilities Management on all products intended for use in the building.
7. Submit in accordance with Division 1 of the Tender Requirements.
8. Product Data:
  - .1 Manufacturer's product literature indicating units and designs selected.
9. Proofs:
  - .1 Submit proofs indicating overall size, layout, wording, kerning, removable and interchangeable components, access panels, fasteners and mounting methods for each required sign.
  - .2 Submit full scale mock ups of signs as required by the UVic RFT document for review by the Consultant and/or Facilities Management. Upon acceptance this sign may be used as a part of the final installation.
  - .3 Do not proceed with fabrication of signage until submittals have been approved by the Consultant and/or Facilities Management.
  - .4 The contractor shall maintain a hand annotated set of Record Drawings to be supplied to Facilities Management at the completion of work.

## **1.6 WORK IN EXISTING PREMISES**

1. Perform Work in or on existing building in accordance with the Specification and Drawings in their entirety as they apply.
2. Execute each part of the Work in existing building by workers specializing in such Work.
3. Patching or replacement of damaged existing surfaces and materials shall be done by workers experienced in the type of Work to be patched. Make patches indistinguishable in final assembly. Paint surfaces out, wall-to-wall in color to match existing where areas are patched.
4. Maintain continuation of fire protection and fire rated assemblies in existing building.
5. Maintain existing exits and provide proper and safe means of egress from all parts of existing building to open spaces at all times to the approval of jurisdictional authorities.

**1.7 OWNER'S USE OF EXISTING BUILDING**

1. The existing building will remain in full use and occupancy throughout the duration of construction of the Work.

**1.8 CONTRACTOR'S USE OF EXISTING BUILDING**

1. Limit access of construction personnel to existing building only at locations approved by the Consultant and/or Facilities Management.
2. Ensure that construction personnel perform Work in existing building only as required under the Contract; and that they do not use rest of building as access to Work Area, except for portions of Work located in other parts of the existing building.
3. Do not interrupt mechanical or electrical services of the existing building unless approved by prior arrangements with the Consultant and/or Facilities Management. Give the Consultant and/or Facilities Management five (5) working days notice of intention to interrupt mechanical or electrical services in the existing building in any area, and obtain written permission from Facilities Management.

**1.9 REGULATORY REQUIREMENTS**

1. Execute the Work in accordance with applicable bylaws, regulations, and building codes; conform to latest published revisions, addenda, supplementary and appropriate current standards presently recognized and enforced by authorities having jurisdiction.
2. All construction must conform with the following laws, regulations, codes, practices and standards, as replaced or amended from time to time, unless specifically exempted on the Building Permit.
  - .1 2012 British Columbia Building Code.
  - .2 2012 British Columbia Fire Code.
  - .3 2012 British Columbia Plumbing Code.
  - .4 2015 British Columbia Electrical Code Regulation.
3. Should conflicts arise between one document or authority and another, obtain clarification from the Consultant and/or Facilities Management before proceeding with the Work. The most stringent regulation will govern.
4. Submit all permits and certificates of inspection provided by authorities having jurisdiction.
5. Should material resembling spray or trowel-applied asbestos be encountered, notify the Consultant

and/or Facilities Management immediately. Work performed on asbestos containing material surfaces shall be undertaken in strict accordance with the Asbestos Handling Procedures. Refer to Appendix B for detailed requirements for handling of asbestos. Provision of all equipment and materials required for asbestos handling is the responsibility of the Contractor.

**1.10 FIRE-RATED ASSEMBLIES**

1. Maintain the continuity of fire-rated assemblies whether or not shown on the Drawings.

**1.11 CONSTRUCTION FACILITIES AND TEMPORARY CONTROLS**

1. Sanitary Facilities: Existing facilities may be used during the construction period. Maintain in clean condition.
2. A continuous supply of potable water will be provided for construction use.
3. Temporary Telephone: Provide and pay for temporary telephone necessary for own use.
4. Arrange with Facilities Management for storage of equipment on site and maintain, in a clean and orderly condition.
5. Maintain the Work in tidy condition, free from the accumulation of waste products and debris.
6. Remove waste material and debris from the building at the end of each working day.
7. Maintain areas free of dust and other contaminants during operations. Prevent spread of dust and contaminants to other parts of the building.
8. Execute the Work in accordance with applicable bylaws, regulations, and BC Building Code; conform to the latest published revisions, addenda, supplementary and current standards. Comply with federal and provincial legislation, guidelines and codes of practice, including WorkSafe BC.

**1.12 MATERIAL AND EQUIPMENT**

1. Product and Material Quality:
  - .1 Defective products will be rejected, regardless of previous inspections. Inspection does not relieve responsibility, but is a precaution against oversight or error. Remove and replace defective products at own expense and be responsible for delays and expenses caused by rejection.
2. Storage, Handling and Protection:
  - .1 Handle and store products in a manner to prevent damage, adulteration, deterioration and soiling and in accordance with manufacturer's instructions when applicable.

- .2 Store packaged or bundled products in original and undamaged condition with manufacturer's seals and labels intact.
3. Manufacturer's Instructions:
  - .1 Unless otherwise indicated in the Specifications, install products in accordance with manufacturer's instructions.
  - .2 Notify the Consultant and/or Facilities Management in writing, of conflicts between the Specifications and manufacturer's instructions, so that the Consultant and/or Facilities Management may establish the course of action.
  - .3 Improper installation or erection of products, due to failure to comply with these requirements, authorizes the Consultant and/or Facilities Management to require removal and reinstallation at no increase in Contract Price.
4. Hazardous Materials Information:
  - .1 Comply with requirements of Workplace Hazardous Materials Information System (WHMIS) regarding use, handling, storage, and disposal of hazardous materials; and regarding labeling and provision of material safety data sheets (MSDS) in accordance with jurisdictional authorities.
  - .2 Deliver copies of Material Safety Data Sheets (MSDS) to Facilities Management on all products intended for use in the building.
  - .3 Refer to Asbestos handling Procedures in attached Appendix B.
5. Workmanship: Workmanship shall be the best quality, executed by workers experienced and skilled in the respective duties for which they are employed. Immediately notify the Consultant if required Work is such as to make it impractical to produce required results.

### **1.13 PROJECT WASTE MANAGEMENT**

1. Employ processes that ensure the generation of as little waste to the landfill as possible including prevention of damage due to mishandling, improper storage, contamination, inadequate protection, or other factors as well as minimizing over packaging and poor quality estimating.
2. Be responsible to provide and pay for proper disposal and salvage of construction materials and waste on the project. Unless otherwise shown on the drawings or described in the specifications, all salvaged materials become the property of the Contractor.
3. Provide a location and facilities for separation of materials for waste or potential salvage and recycling. Recycled materials may be collected together and sorted off-site.
4. Hazardous materials are to be separated, stored and disposed of in accordance with the requirements of the authorities having jurisdiction including the Provincial Waste Management Act and BC Special Waste Regulation.

**1.14 PROGRESSIVE CLEANING**

1. Maintain the Work in tidy condition, free from accumulation of waste products and debris.
2. Make arrangements with and obtain permits from authorities having jurisdiction for disposal of waste and debris.
3. Remove waste material and debris from the site and deposit in waste container at the end of each working day.
4. Do not dispose of waste or volatile materials such as mineral spirits, solvents, oil, or paint thinner into sewer or drainage systems.

**1.15 PROJECT CLOSEOUT**

1. Final Cleaning:
  - .1 Leave the Work broom clean before the inspection process commences.
  - .2 Clean and polish glass, hardware, stainless steel, aluminum, chrome, porcelain enamel, baked enamel, plastic laminate, Lamacoid, vinyl, mechanical and electrical fixtures.
  - .3 Replace broken, scratched or disfigured glass.
  - .4 Remove stains, spots, marks and dirt from decorative Work, electrical and mechanical fixtures, furniture fittings and walls.
  - .5 Vacuum clean and dust building interiors, inside millwork, behind grilles, louvres and screens.
  - .6 Damp mop floors in preparation for sealing and waxing.
2. Upon completion of the Work, submit to Facilities Management red-line, hand-edited, Record Drawings of each sign in the Work of this Contract. Refer to 1.5 Submittals.
3. Submit manufacturer's maintenance instructions, and necessary tools to change signage. Include a written record of all drawings and materials including quantities submitted to the Owner at completion of Work.

**END OF SECTION**

**1 GENERAL****1.1 DOCUMENTS**

1. This Specification document forms part of the Contract and is to be read, interpreted and coordinated with all other parts, including the Tender Requirements issued under separate cover.

**1.2 SUMMARY**

1. Provide material, equipment and services necessary for and incidental to the supply and installation of directional signage as indicated and specified.

**1.3 QUALITY CONTROL**

1. Installer: Company specializing in the installation of signs specified with a minimum of five (5) years proven experience for projects of similar size and complexity.

**2 PRODUCTS****2.1 MANUFACTURERS**

1. Trotec Laser (1-800-663-1149) [troteclaser.com](http://troteclaser.com).
2. ND Graphics (604-527-7940) [ndgraphics.com](http://ndgraphics.com)
3. Scapa North America (1-613-432-8545) [scapa.com](http://scapa.com).
4. 3M Canada (1-800-364-3577) [solutions.3mcanada.ca](http://solutions.3mcanada.ca)
5. Mustang Systems (1-866-288-3946) [mustang-systems.ca](http://mustang-systems.ca)
6. Richelieu (1-800-361-6000) [richelieu.com](http://richelieu.com)
7. Com Sign (1-888-452-9019) [commercialsigns.com](http://commercialsigns.com)
8. Acklands-Grainger Inc. (250-384-1111) [acklandsgrainger.com](http://acklandsgrainger.com)
9. Rowmark (1-877-769-6275) [rowmark.com.com](http://rowmark.com.com)
10. ULine (1-800-295-5510) [uline.ca](http://uline.ca)

**2.2 FASTENERS**

1. In a solid block/concrete wall surface:
  1. Use metal self-expanding anchors and screws, of an appropriate length and number to support sign load.
2. In a gypsum board wall surface:
  1. Size screws to ensure 6mm (1/4") minimum to 13mm (1/2") maximum penetration into studs behind drywall.



2. Use metal self expanding drywall anchors and screws of appropriate size and strength to support load at unsupported drywall locations.

### **2.3 FABRICATION**

1. Metric dimensions are rounded up/down and are for information only. Signs are to be built to Imperial dimensions.
2. All centred text is based on centre of uppercase letters. Do not consider ‘tails’ of letters which extend below baseline.
3. All text dimensions are based on the physical dimensions of an uppercase “O” and not on font sizes.
4. Kerning shall be set to manual and zero.
5. Build units square, true, accurate to size and free from visual or performance defects.
6. Accurately fit and securely join sections to obtain tight, closed joints except where reveals are detailed.
7. Exposed fasteners permitted only where indicated or approved by the Consultant and/or Facilities Management and to be inconspicuous and same finish and colour as base material, or as noted.
8. Polish exposed edges to smooth, slightly convex profile.
9. Apply isolating coating to aluminum in contact with dissimilar metals, concrete or masonry.
10. Manufacturer’s nameplates on sign surface locations to be invisible in completed work.
11. Rotary engravers must be used for both tapered lettering and engraving for setting braille beads.

## **3 EXECUTION**

### **3.1 EXAMINATION**

1. Examine the job conditions and surfaces to which the work is to be fixed. Be responsible for selecting suitable mounting or graphic technique for each sign. Do not mount signs onto surfaces which are not flat. Do not mount signs in locations which will obscure lights, exit signs or other signs.
2. Report to the Consultant and/or Facilities Management unsatisfactory conditions preventing the proper installation of the Work.
3. Commencement of the Work implies acceptance of the surfaces and conditions.

### **3.2 INSTALLATION**

1. Deliver signs to the site fully assembled complete with all mounting screws and other accessories. Signs to be disassembled as necessary for mounting.

2. Locate signs plumb, level and true according to Drawings and site instructions. Provide necessary shims.
3. Comply with sign manufacturer's installation instructions and approved proofs/shop drawings.
4. Review the installation locations and conditions with the Consultant and/or Facilities Management prior to installation of signs to ensure understanding and compliance with the intent of the Specifications.

### **3.3 TOUCH UP**

1. Remove fingerprints and other markings and leave faces and edges in clean condition.
2. Remove markings made during the course of installation from adjacent finished surfaces. Restore finishes as necessary to original condition.

### **3.4 ADA COMPLIANCE**

1. All braille shall be ADA compliant, shall be domed or rounded and shall be raised between 0.6mm (.025") and 0.9mm (.037") above the surface of the sign.
2. All raised lettering shall be ADA compliant and shall be tapered at an angle of 22 degrees from the vertical.

### **3.5 TEXT MEASUREMENT**

1. All text sizes referred to in this document refer to the physical measurement of capital letters and do not refer to font sizes.

### **END OF SECTION**

**MATERIALS LIST**

- ① Silver Plastic Laminate: Supplied by Richelieu  
Nevamar MXT003T Silver, Grade: HF-4 (HGP) 0.039”  
-Grain to run horizontal
  
- ② Gerber Vinyl Text/Logo/Graphic: Supplied by ND Graphics  
FX Foils printed on GSP 220 15” wide white vinyl:
  - a) Red datum line: “Ruby Red” GCS-53
  - b) Black graphic: “Black” GCS-12
  - c) UVic Logo: “Cobalt Blue” GCS-37
  - d) UVic Logo: “Tomato Red” GCS-13
  - e) UVic Logo: “Yellow” GCS-15
  - f) Building Directory: “White” GSP-220
  - g) Recycling: “Dark Green” GCS-56
  - h) Recycling: “Vivid Blue” GCS-17
  - j) Recycling: “Grey” GCS-31
  - k) Recycling: “Orange” GCS-14

Note: All vinyl text/logo/graphic to be flat cut.
  
- ③ Lamacoid: Supplied by Engraver’s Express  
Multi-layered abrasion, heat and chemical resistant phenolic sheet stock  
EnCore ArmorCore 312-227m (1/16” - 1.6 mm) Grey/White  
b) EnCore UltraCore 602-223 (1/16” - 1.6 mm) Red/White  
c) EnCore Matte 502-222 (1/16” - 1.6 mm) Sapphire Blue/White  
d) EnCore Satin 932-221 (1/16” - 1.6 mm) Bright Green/White  
e) EnCore Satin 704-221 (1/16” - 1.6 mm) Yellow/Black  
f) EnCore Satin 206-221 (1/16” - 1.6 mm) White/Red  
g) EnCore Matte 612-222 (1/16” - 1.6 mm) Orange/White  
h) EnCore Matte 552-222 (1/16” - 1.6 mm) Navy Blue/White  
j) EnCore Matte 602-222 (1/16” - 1.6 mm) Red/White  
k) EnCore Matte 744-222 (1/16” - 1.6 mm) Yellow/Black  
m) EnCore Matte 932-222 (1/16” - 1.6 mm) Bright Green/White  
n) EnCore UltraCore 512-223 (1/16” - 1.6 mm) Blue/White  
p) EnCore Matte 562-222 (1/16” - 1.6 mm) Sky Blue/White
  
- ④ Text/Arrow/Graphic Engraved into Lamacoid; cutter size and depth as required to create sharp edges/corners and match existing signs. Typeface to be Myriad Pro Semibold unless implicitly stated otherwise. Kerning to be set to Manual / 0.
  
- ⑤ Metal Angle Frame: Supplied by Richelieu  
1/16” x 1/2” x 1” Anodized Aluminum alloy; Satin Finish
  
- ⑥ 3/4” G1S Plywood backer board, clear finish

**MATERIALS LIST CONTINUED:**

- ⑦ Hanging sign hardware manufactured by Mustang Systems ([www.mustang-systems.ca](http://www.mustang-systems.ca)) and supplied by Westwind Design in Calgary, Alberta, or Mustang Visual Displays in Ontario. Approved alternatives may be used.  
Suspension Panel Kit: C1103 Suspension Panel Kit  
For dropped ceilings include: C1712 Ceiling Shield  
- Attach to ceiling with Robertson FH#10 screws
- ⑧ Contact cement: LePage Pres-Tite Green Contact Cement, designed to bond Lamacoid/laminate to wood
- ⑨ Robertson FH#8 Screw
- ⑩ Custom 14 gauge Aluminum Backer/Mounting Bracket, edges ground smooth
- ⑪ Non-glare Clear Acrylic Sheet / Plexi - 2mm  
b) 3mm [1/8"]  
c) 6mm [1/4"]
- ⑫ Braille Raster Balls (Raster Spheres), clear finish.  
Contractor to translate relevant sign information to Grade 2 Braille where Braille is specified.  
-See note in Section 3.4 regarding ADA compliance.
- ⑬ Double Sided Tape: Supplied by Engraver's Express  
Scapa Extra Tack 4403; To adhere plastic Lamacoid to aluminum backer/aluminum backer to aluminum backer; To adhere Lamacoid strips -Tape entire perimeter of signs
- ⑭ Double Sided Tape: Supplied by Engraver's Express  
Scapa Extra Tack 4403; To adhere Lamacoid strips -Tape entire perimeter of signs  
For ID5 and ID6 Room occupant badges and name plates use Double Sided Tape: Supplied by Acklands Grainger 3M Highland 9579; To adhere removable Lamacoid strips  
-Tape entire perimeter of signs
- ⑮ Clear finished, 3/4" good both sides birch plywood backer
- ⑯ T-slot  
Router a standard t-slot into the back of the plywood to accept:  
- a #8 wood screw or similar fastener if fastened to a GWB wall  
- either a wood screw with a concrete anchor or a tapcon / scru-it anchor or similar if fastened to a concrete/block wall
- ⑰ Mustang 2021-8 Shelf Panel Support  
-shim as needed

**MATERIALS LIST CONTINUED:**

- 18) Lamacoid: Supplied by Engraver's Express  
Multi-layered abrasion, heat and chemical resistant phenolic sheet stock.  
Lamacoid embossing material applied to main Lamacoid panel with text cut out leaving it embossed on panel.  
1/32' Encore Braille Core with adhesive backing  
- Embossed letters/numbers "Bright White" 204-113  
Rooms are to be Numbered with uppercase prefixes and lowercase suffixes where used (i.e. A202b)  
Kerning to be set to Manual / 102.  
-See note in Section 3.4 regarding ADA compliance for letters.
- 19) Pan head screws, finish to match aluminum backer  
To secure projecting signs to walls
- 20) Double Coated Foam Tape: Supplied by Acklands  
12mm 3M 4026; To adhere clear plexi sheet to plastic laminate, and Lamacoid to walls/doors.  
Replace with 34) 3M Highland 4905 VHB when adhering signs to glass or to lacquered doors.
- 21) 0.5mm Thick High Impact Styrene
- 22) 3mm Sintra Foam Board, White
- 23) Plastic Laminate, white to shim
- 24) Dibond e-panel  
-3mm White/White
- 25) Trotec 2x8" Desk Name Plate Holder  
-Silver #48-8-S
- 26) Trotec 2x8" Flat Name Plate Holder  
-Silver #36-8-S
- 27) Mustang Fiberglass Clamp System  
-MSMB 2.4" x 3/4")
- 28) Mustang Aluminum Clamp System  
a) MSB60 (2.4" x 7/8")  
b) MSB100 (4" x 7/8")  
c) MSB200 (8" x 7/8")  
d) MSB300 (12" x 7/8")
- 29) Mustang Panel Support  
a) C1201 6mm Single Support for Panel
- 30) Mustang C1100 Floor to Ceiling Fixing Kit

**MATERIALS LIST CONTINUED:**

- ③1 Mustang Wall Mounted Swivel Kit
  - a) C1109 (No Wall Plates)
  - b) C1102 (With Wall Plates)
  
- ③2 Mustang Side Grip Standoff
  - a) 2015 (19mm [3/4"] diameter, 4mm slot)
  - b) 2020 (19mm [3/4"] diameter, 8mm slot)
  
- ③3 Richelieu Premium Magnetic Whiteboard
  
- ③4 Double Sided Tape: Supplied by ULine  
3M Highland 4905 VHB 1/2"; To adhere signs to glass or to lacquered doors  
-Tape entire perimeter of signs

NOTE: Where an adhesive listed above is deemed to be inappropriate for the materials that are being adhered together, contact the Consultant and/or Facilities Management with alternates and provide backup information from the supplier regarding the alternate's suitability.

NOTE: All descriptions of materials in Detail Drawings are for convenience only. See Materials List for complete specification.

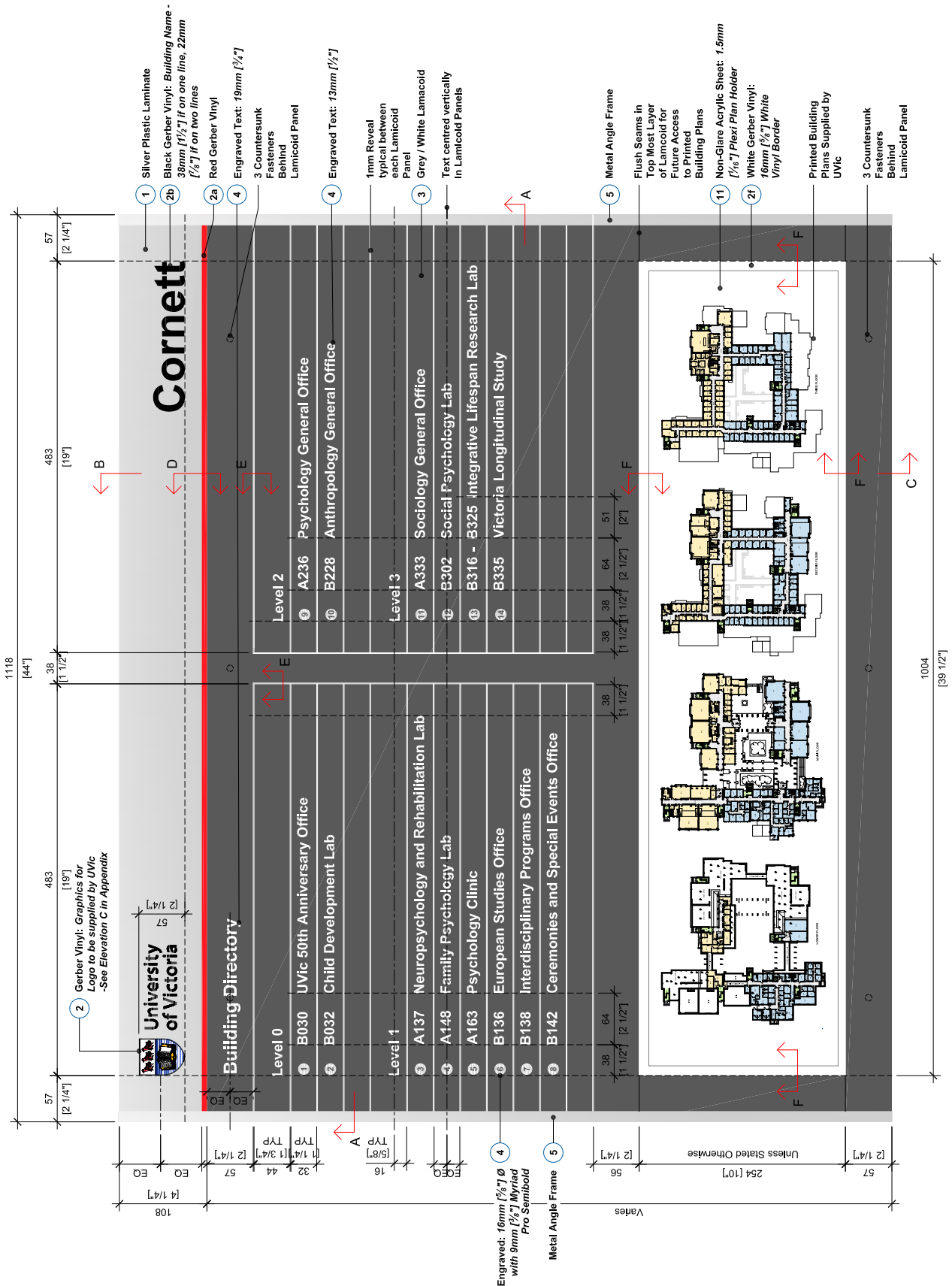



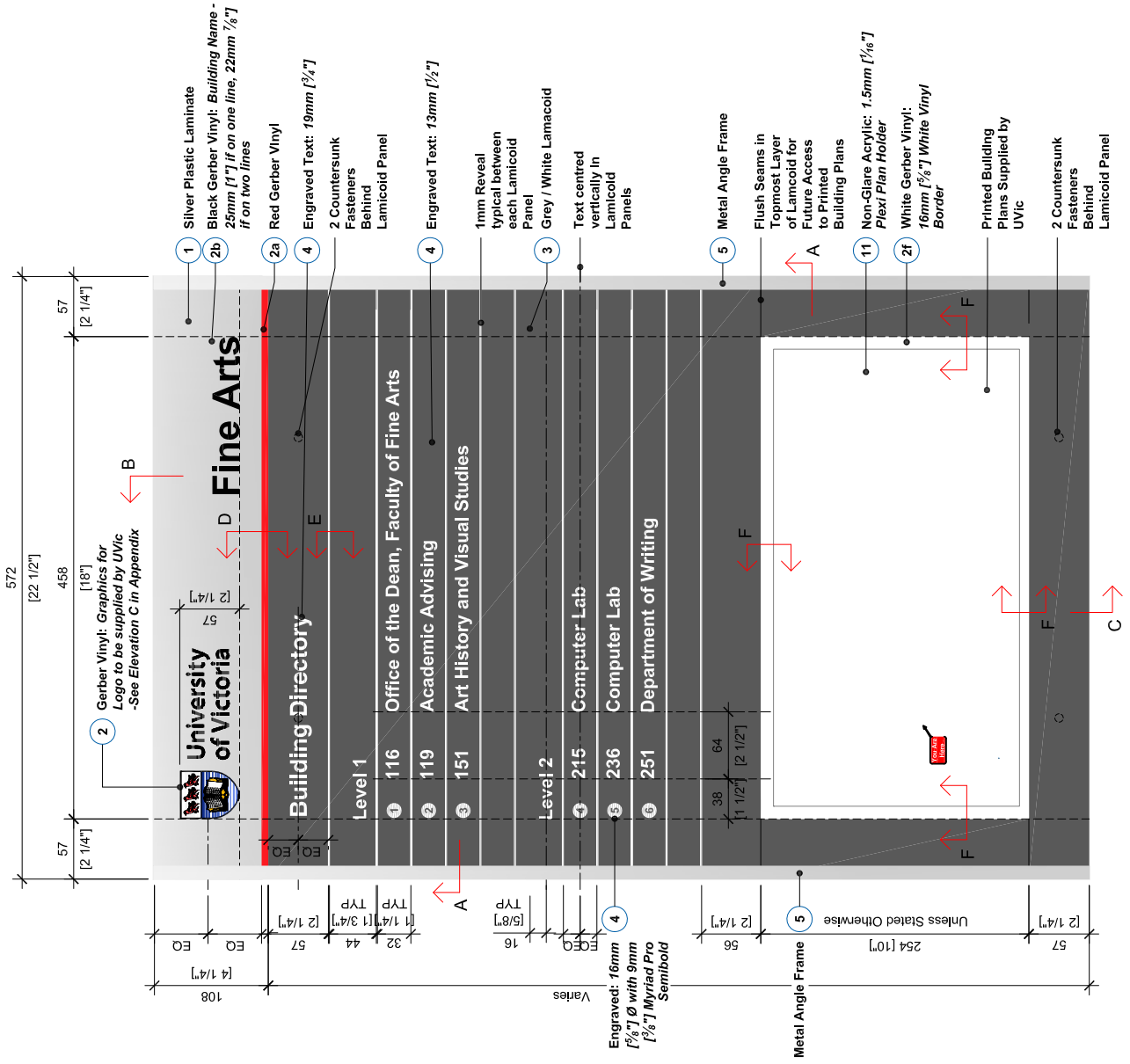

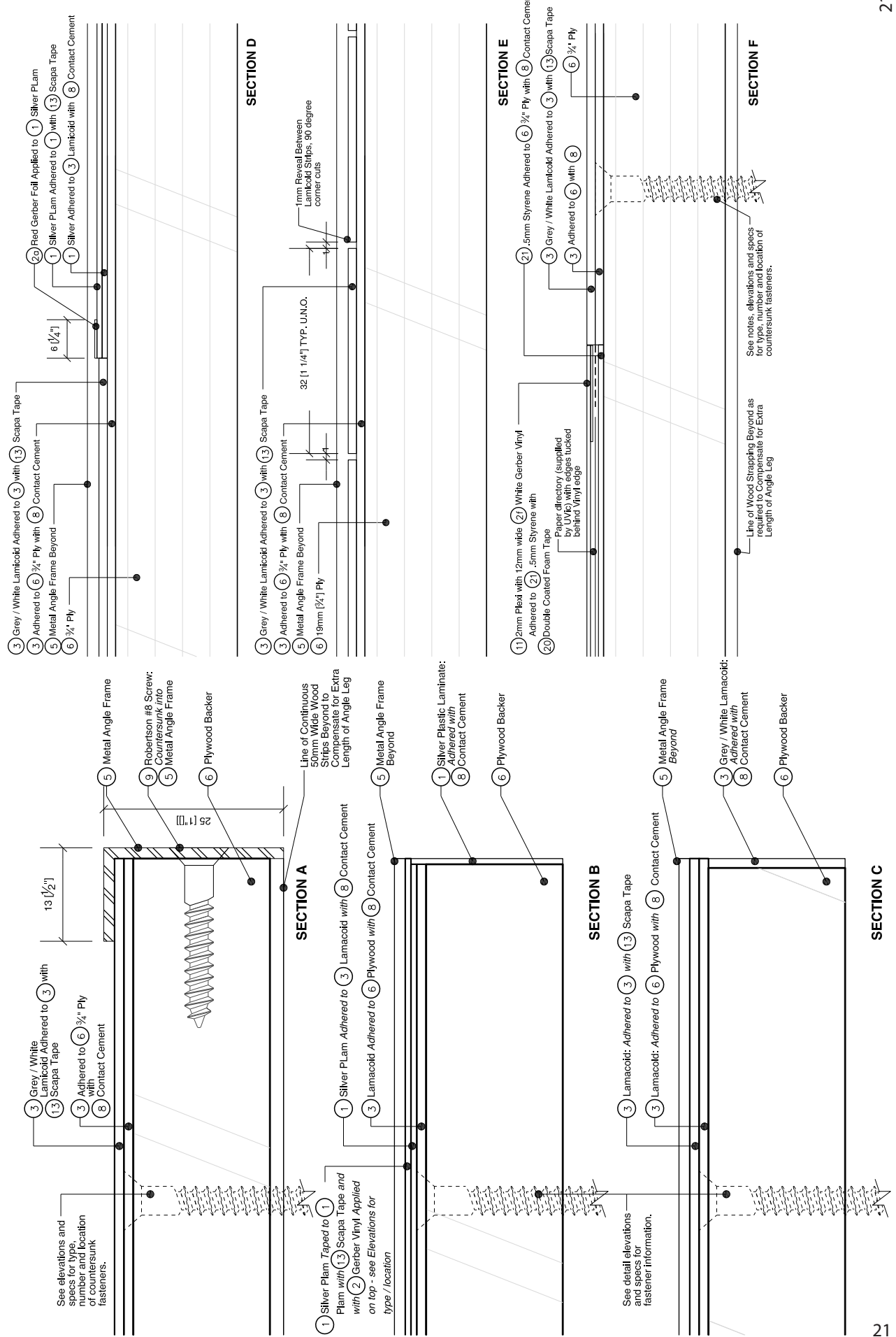

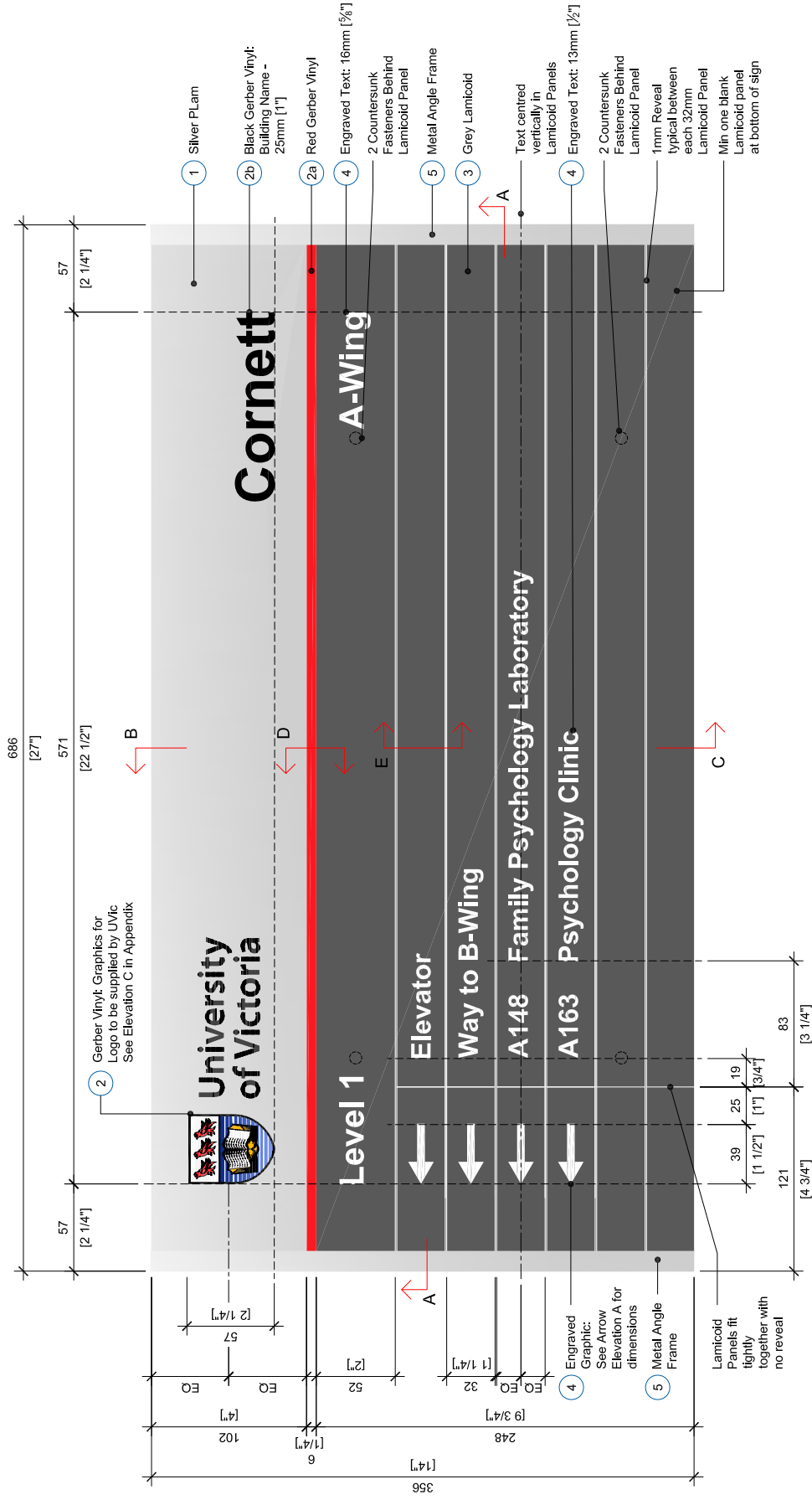

Sub-Directory 3-5 Lines [SD1]

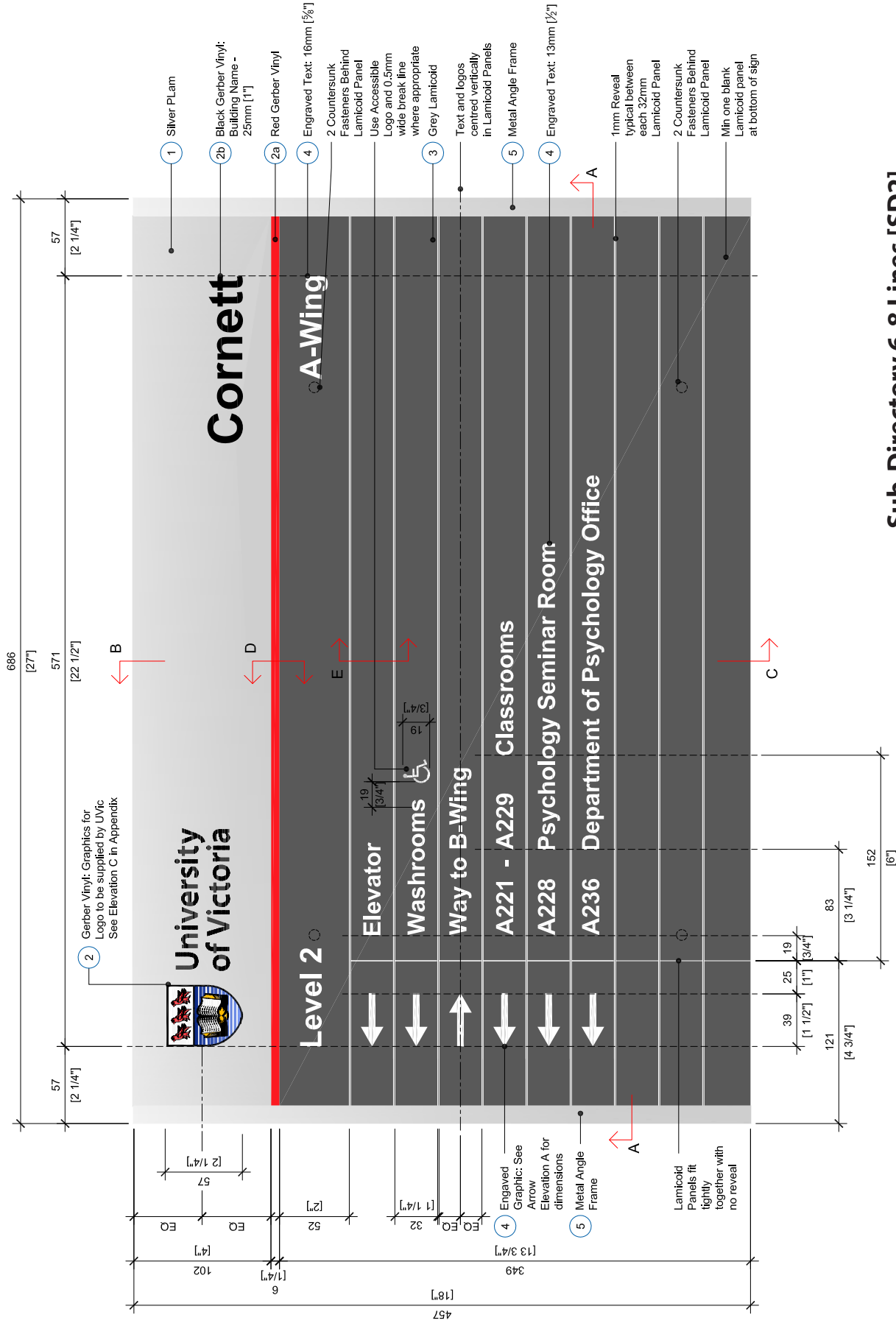

Sub-Directory 6-8 Lines [SD2]

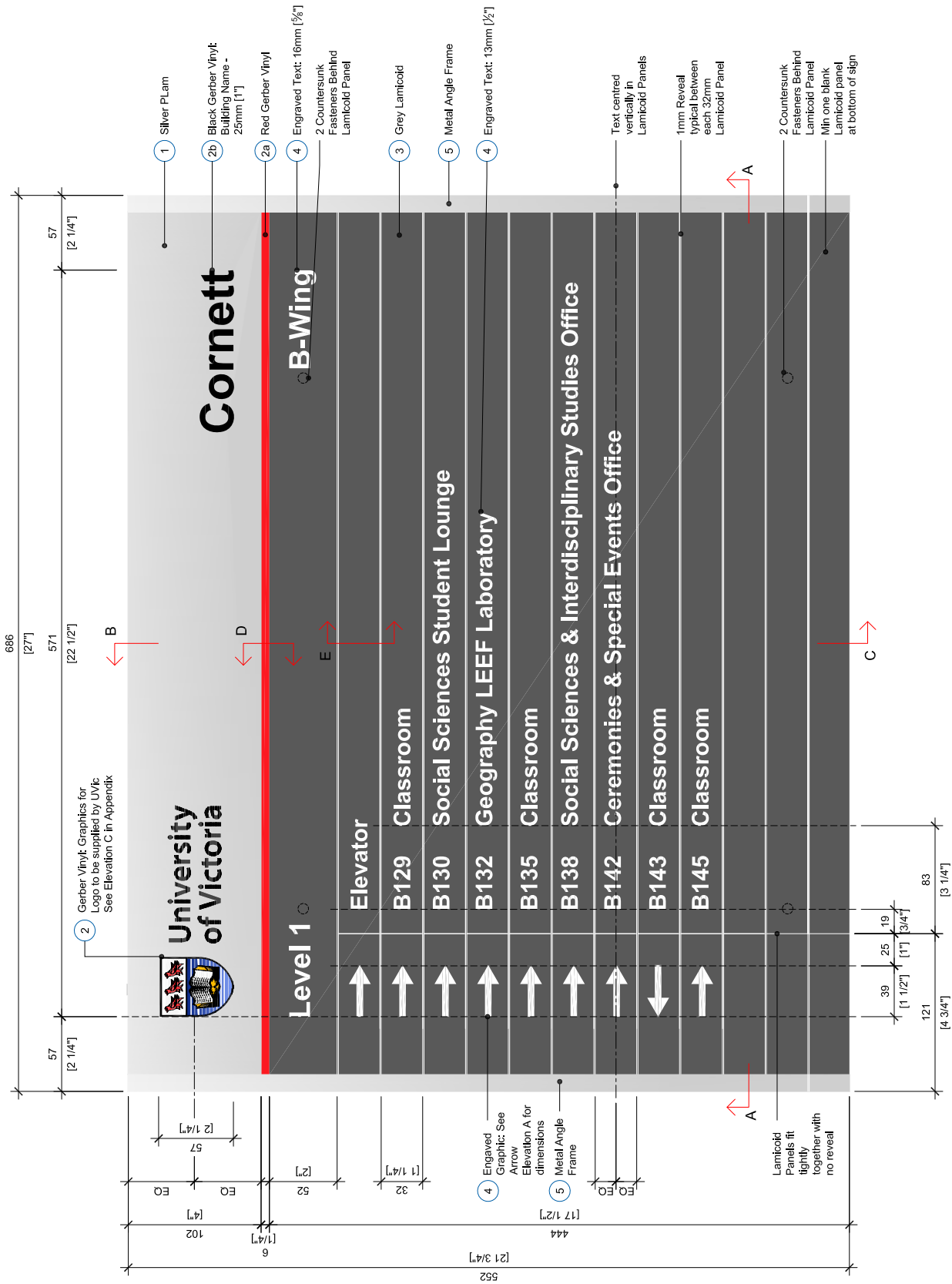

Sub-Directory 9-11 Lines [SD3]

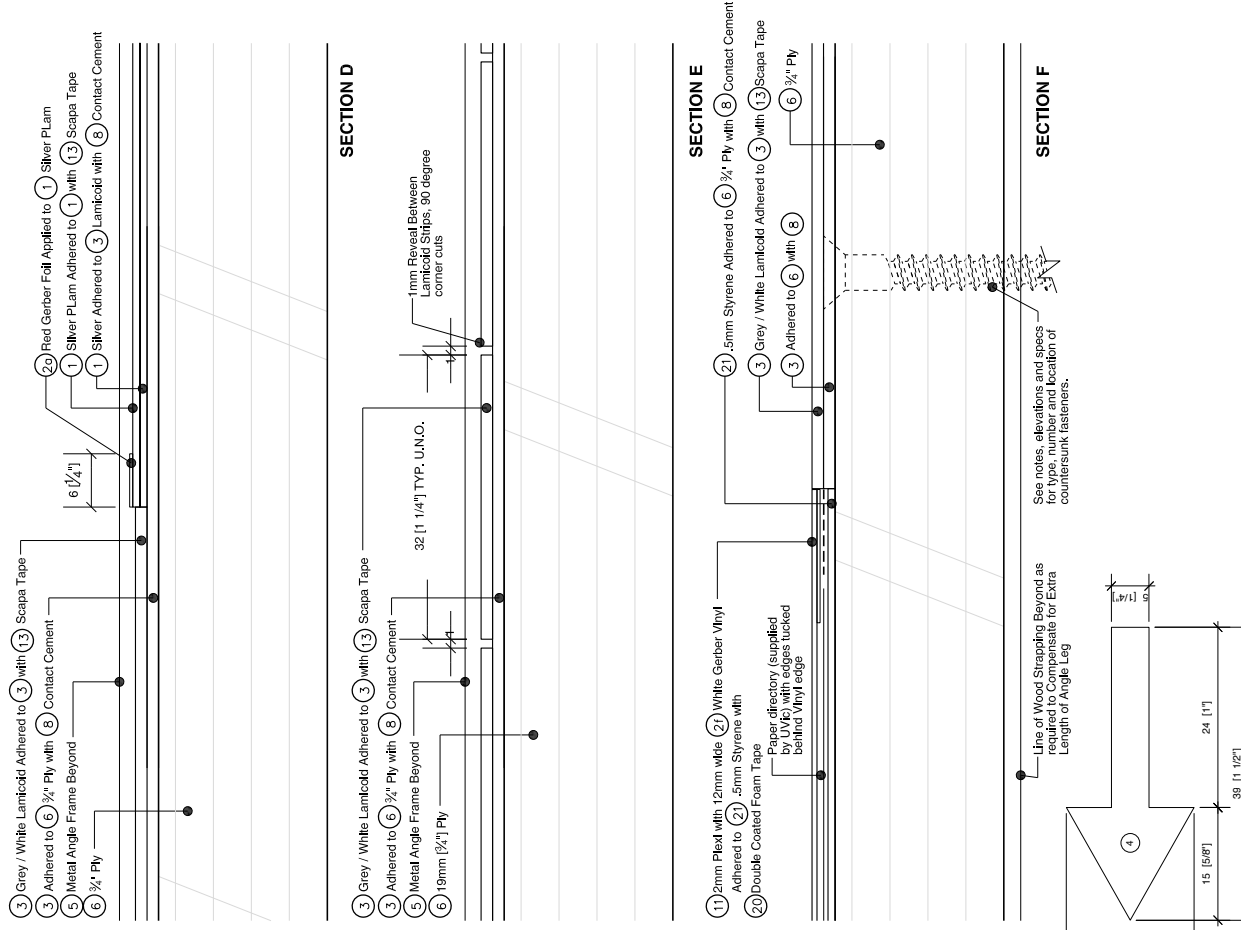
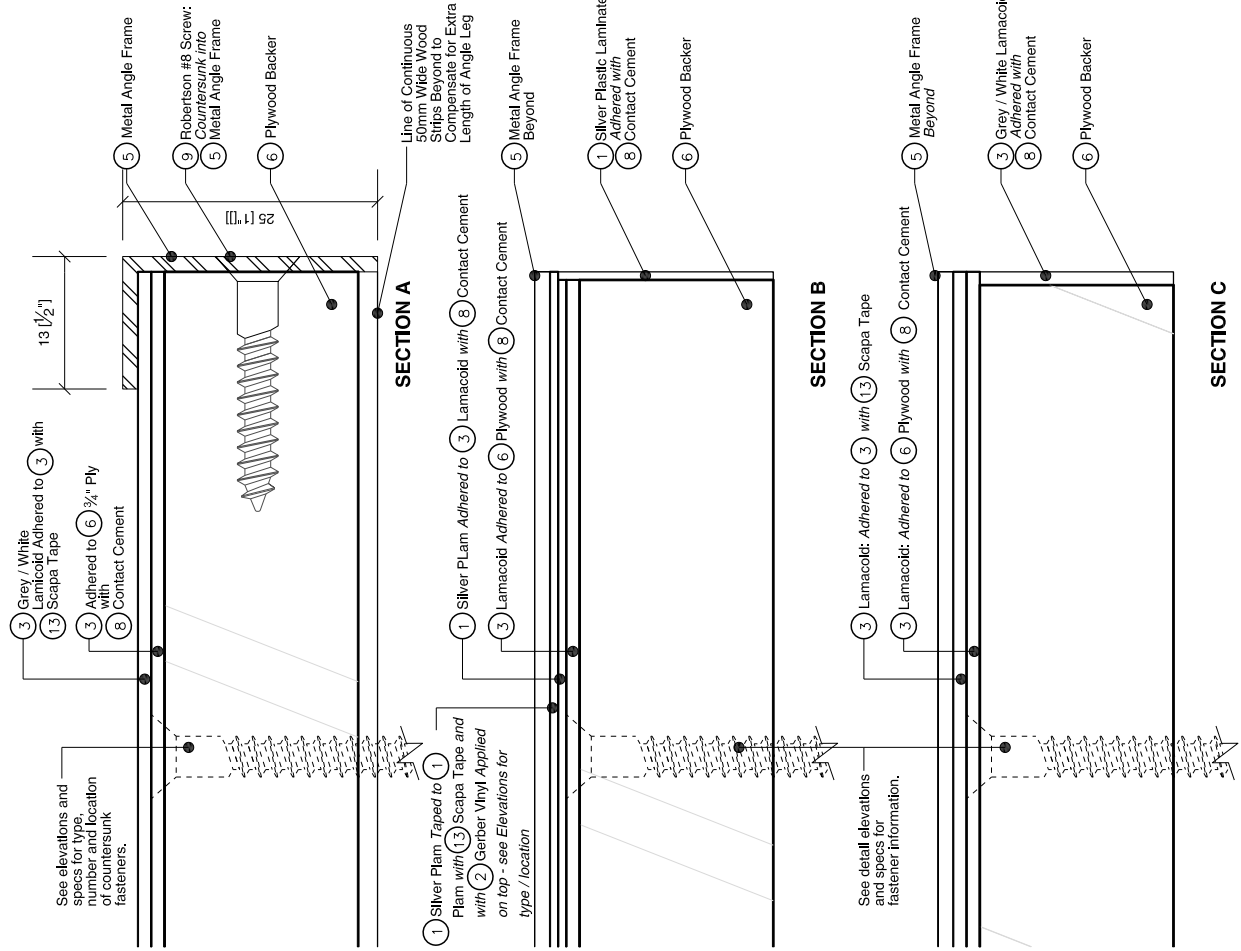

See elevations and specs for type, number and location of countersunk fasteners.

See detail elevations and specs for fastener information.

See notes, elevations and specs for type, number and location of countersunk fasteners.

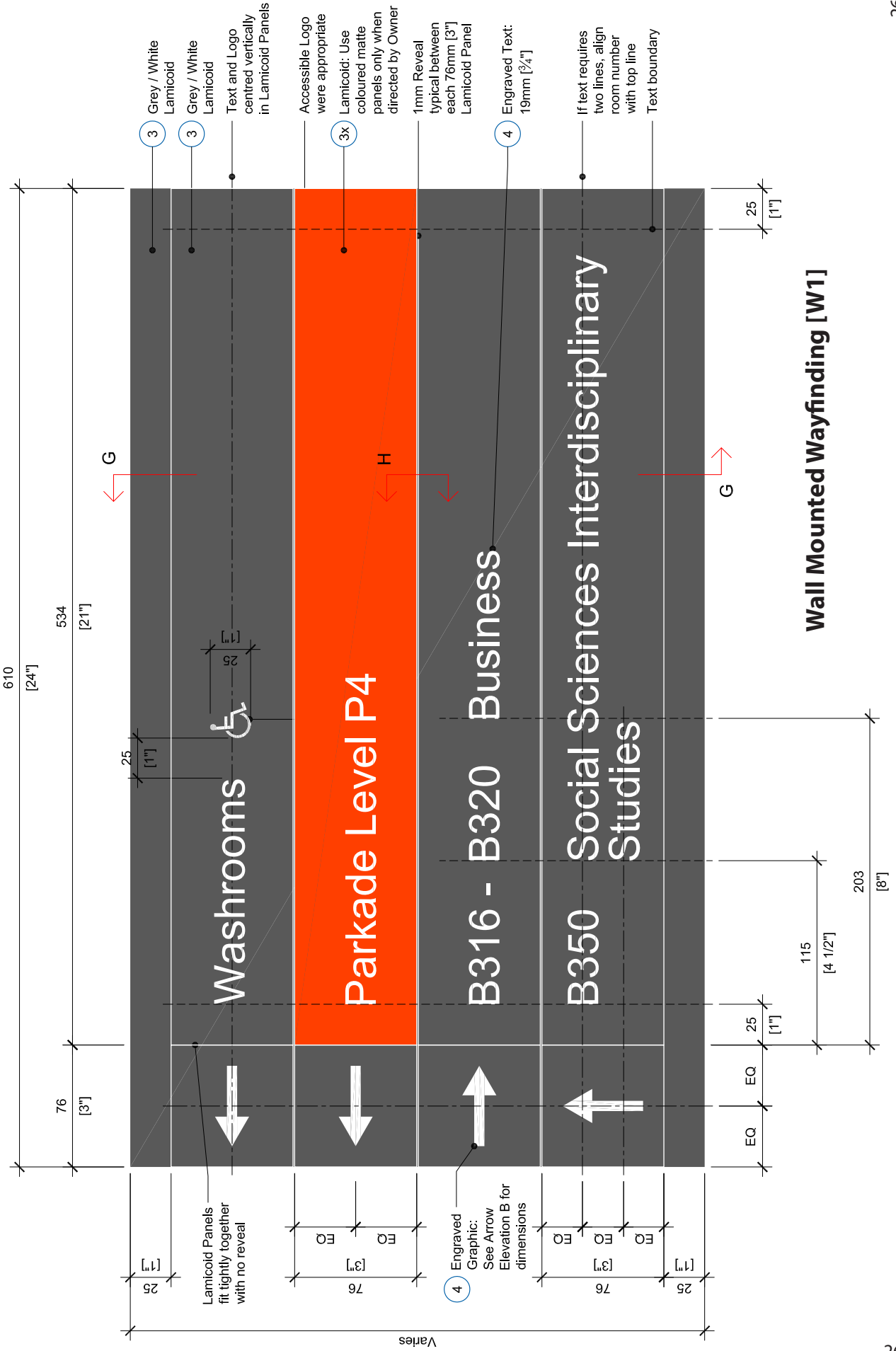

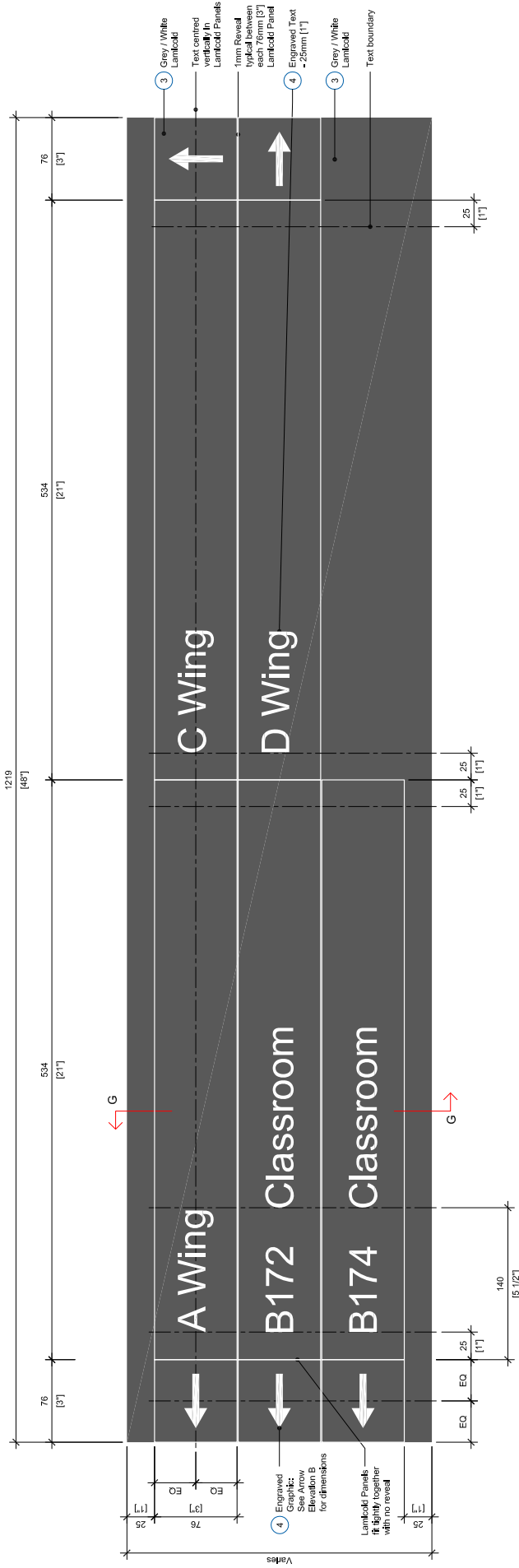

Double-Wide Wall Mounted Wayfinding [W1a]



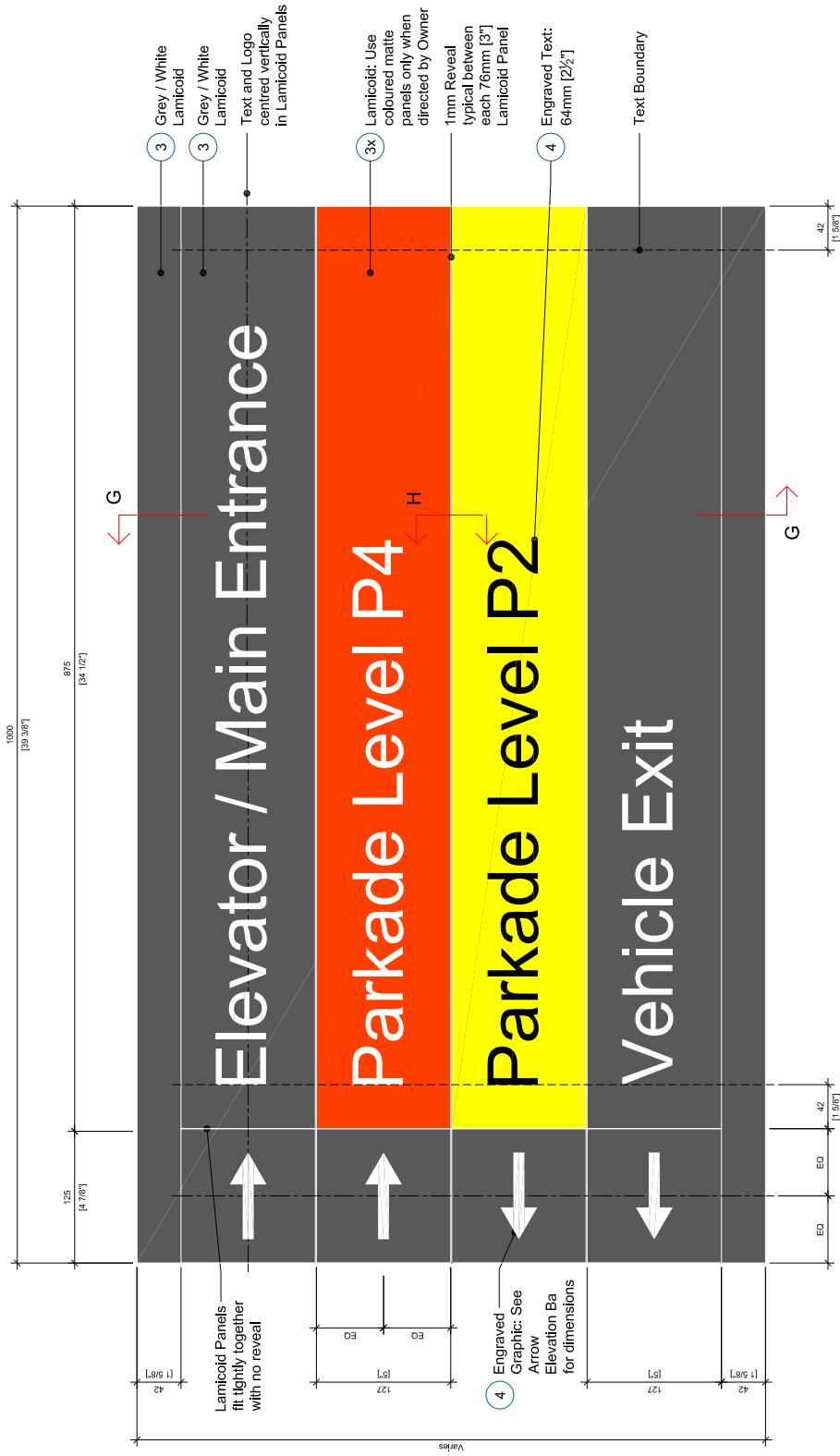

Large Wall Mounted Wayfinding [W1b]

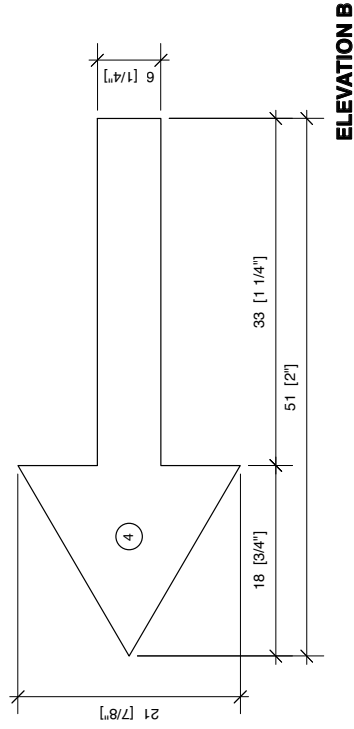
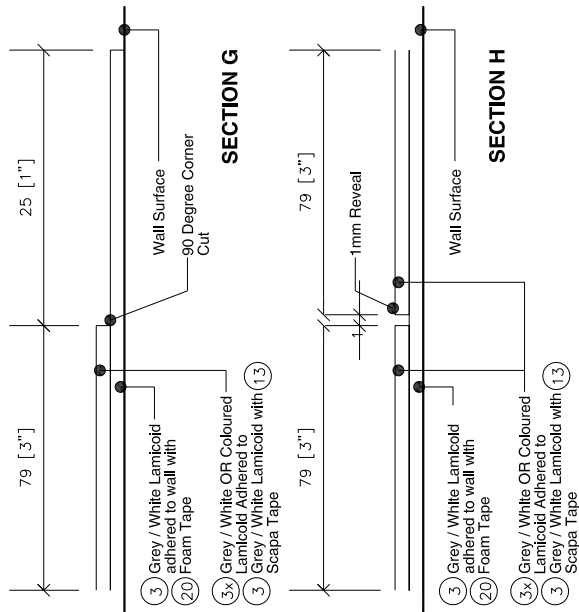

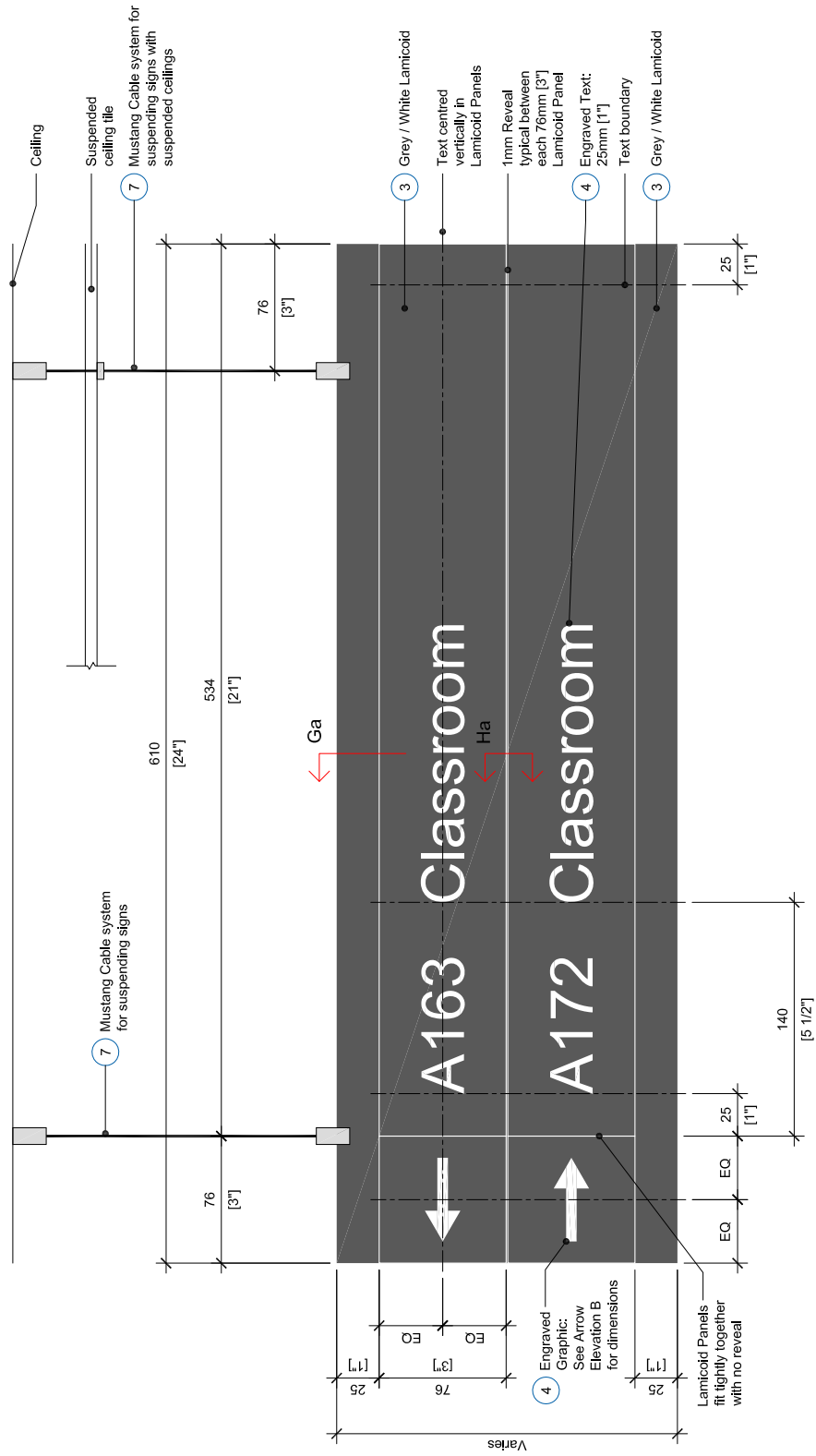

Suspended Wayfinding [W2]

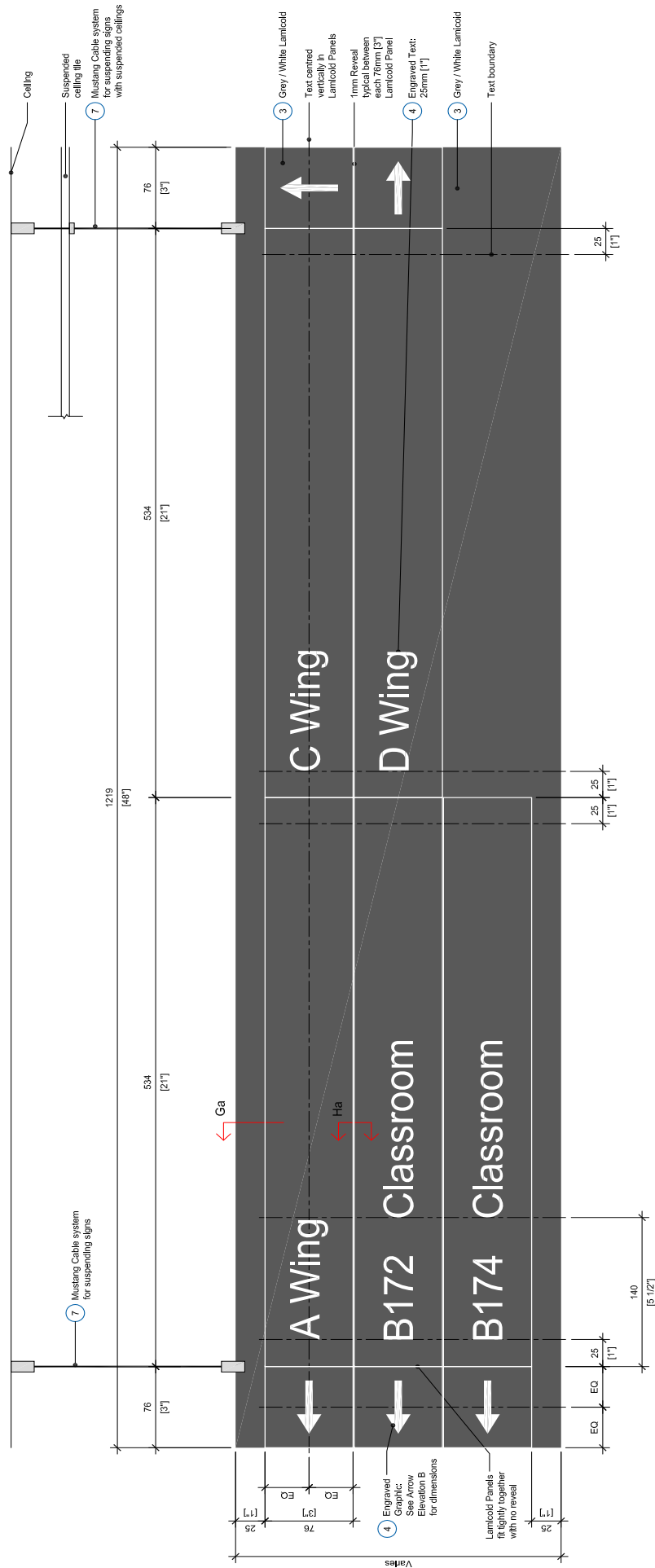

Double-Wide Suspended Wayfinding [W2a]

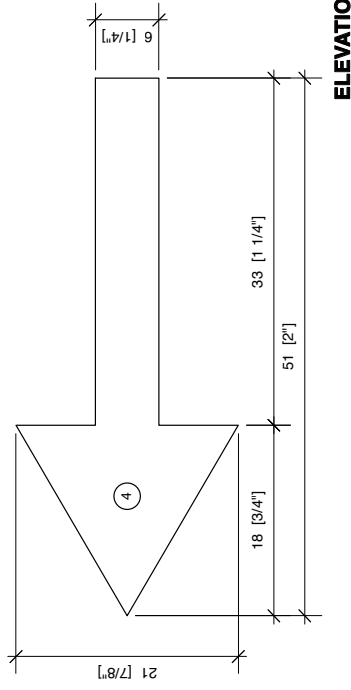
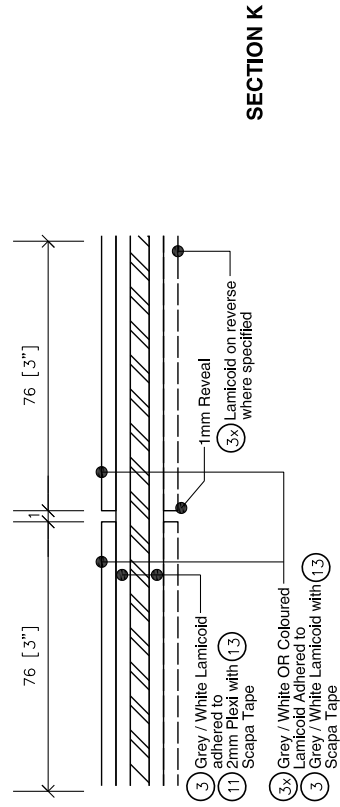
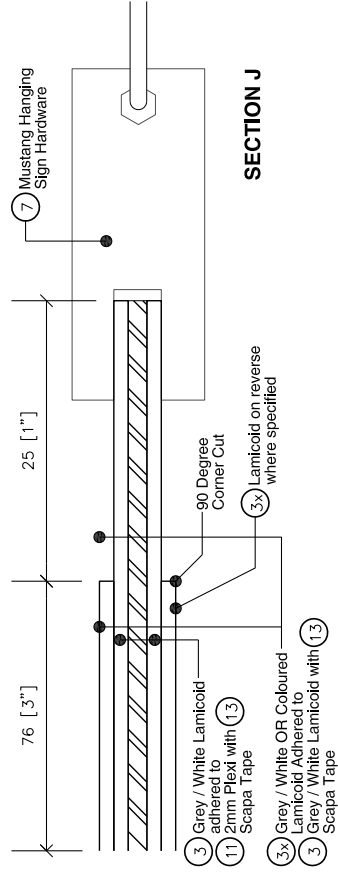

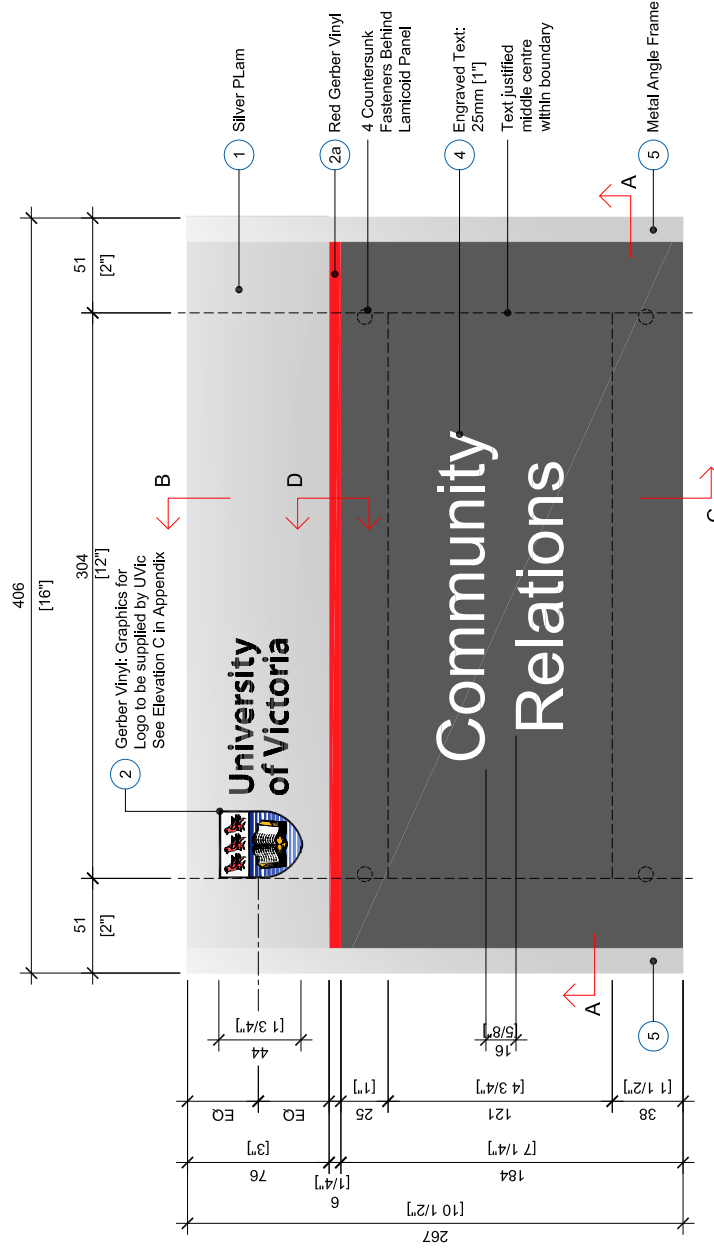

DEP1a

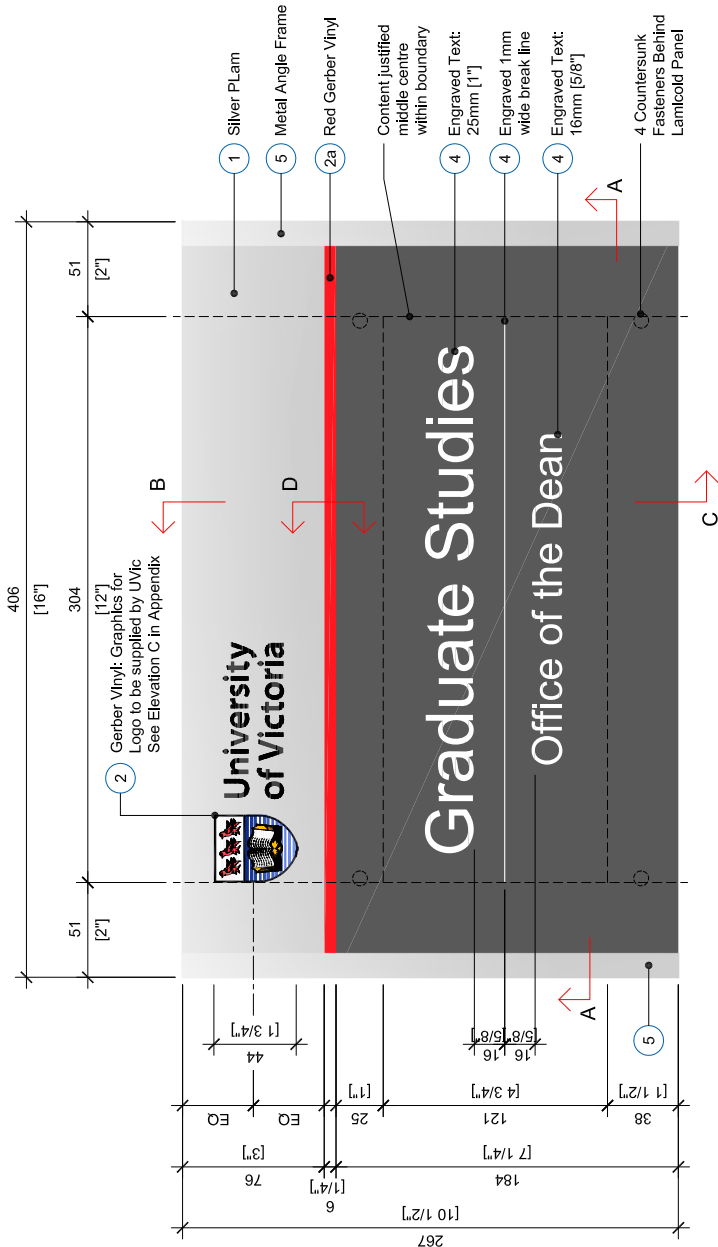

**DEP1b**

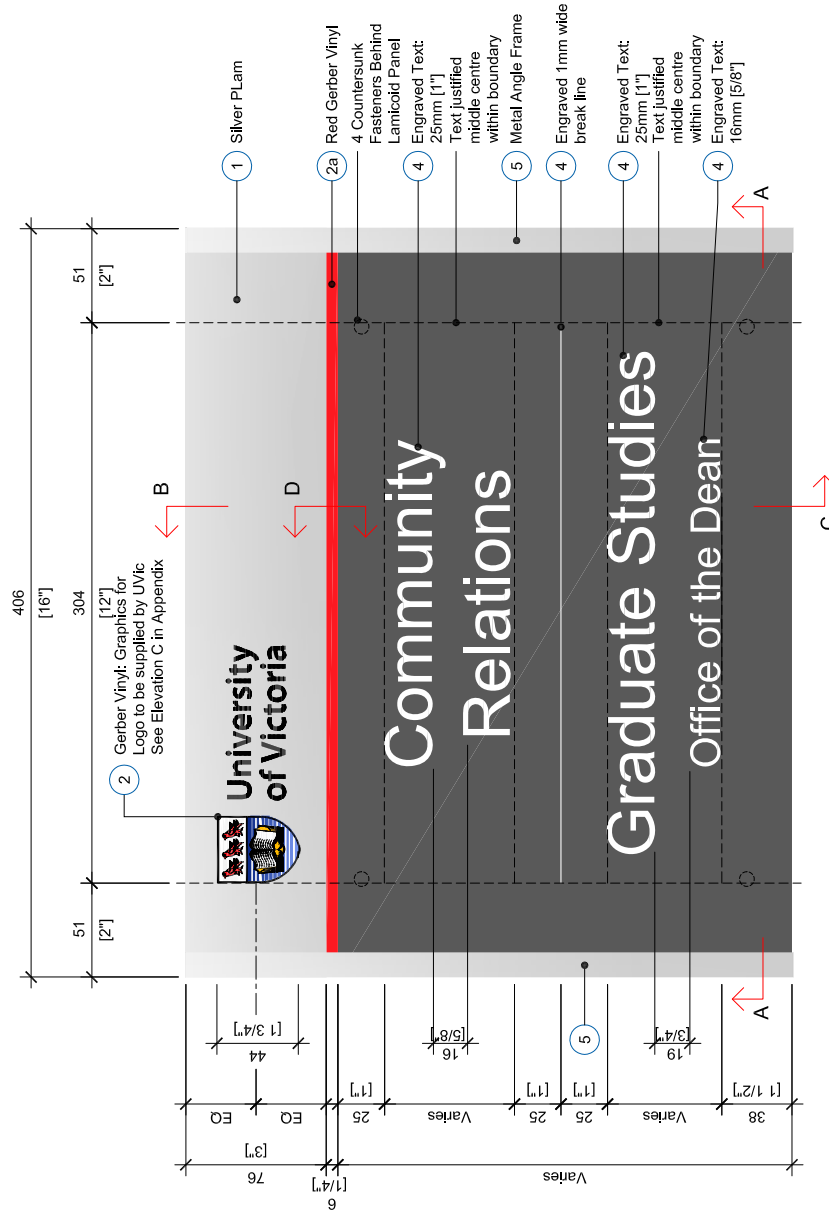

DEP1c



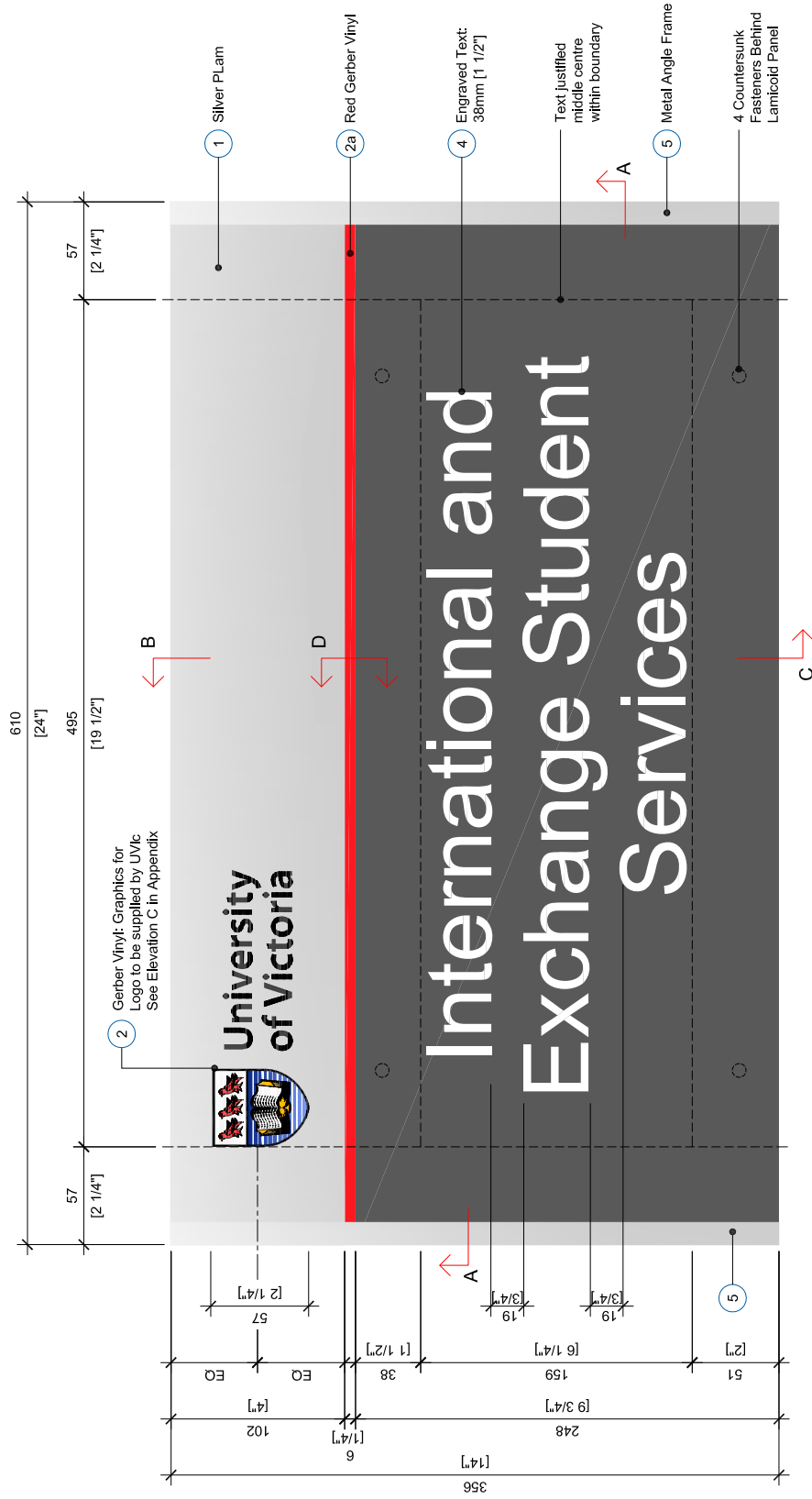

DEP2a

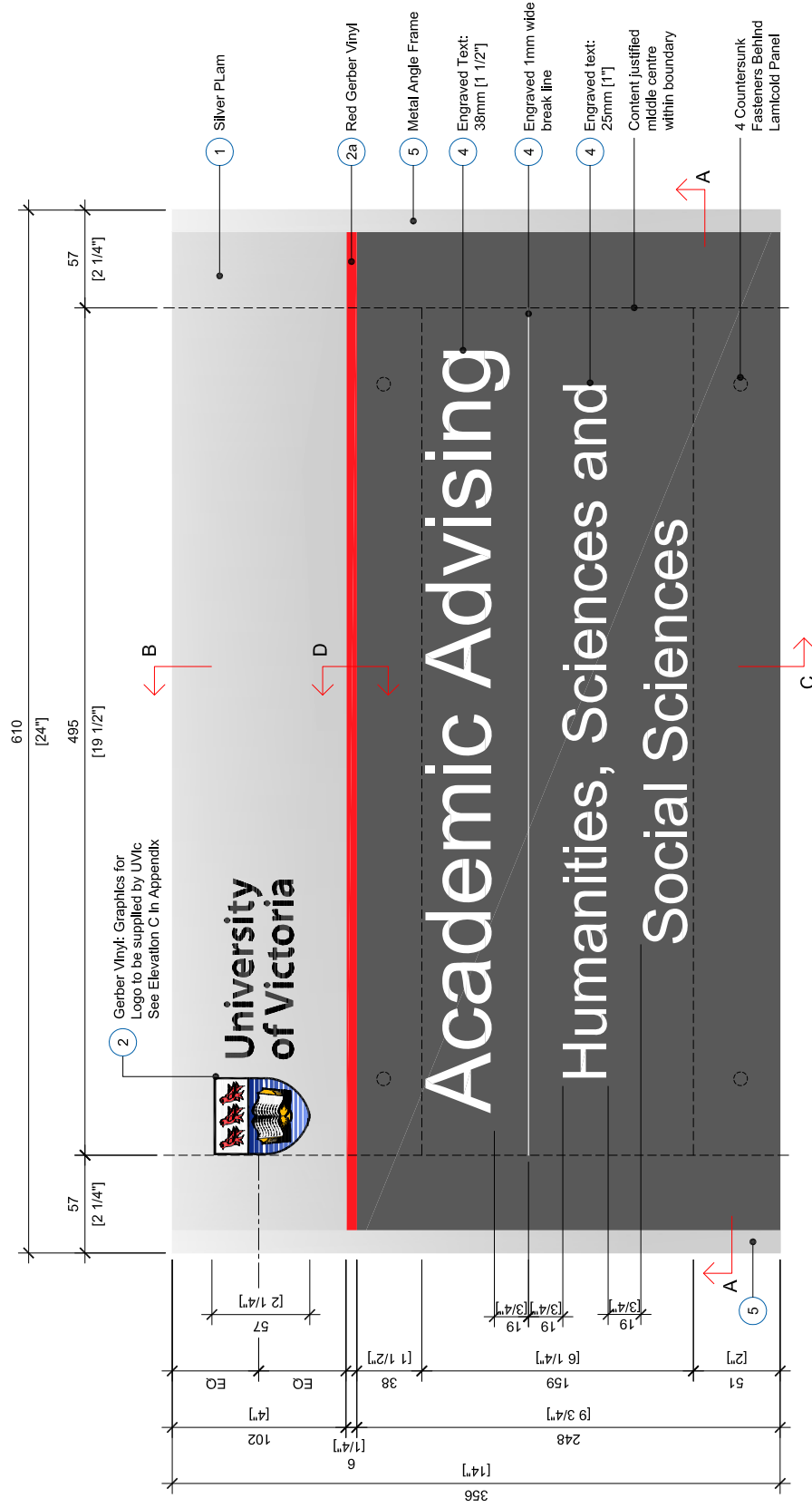

DEP2b

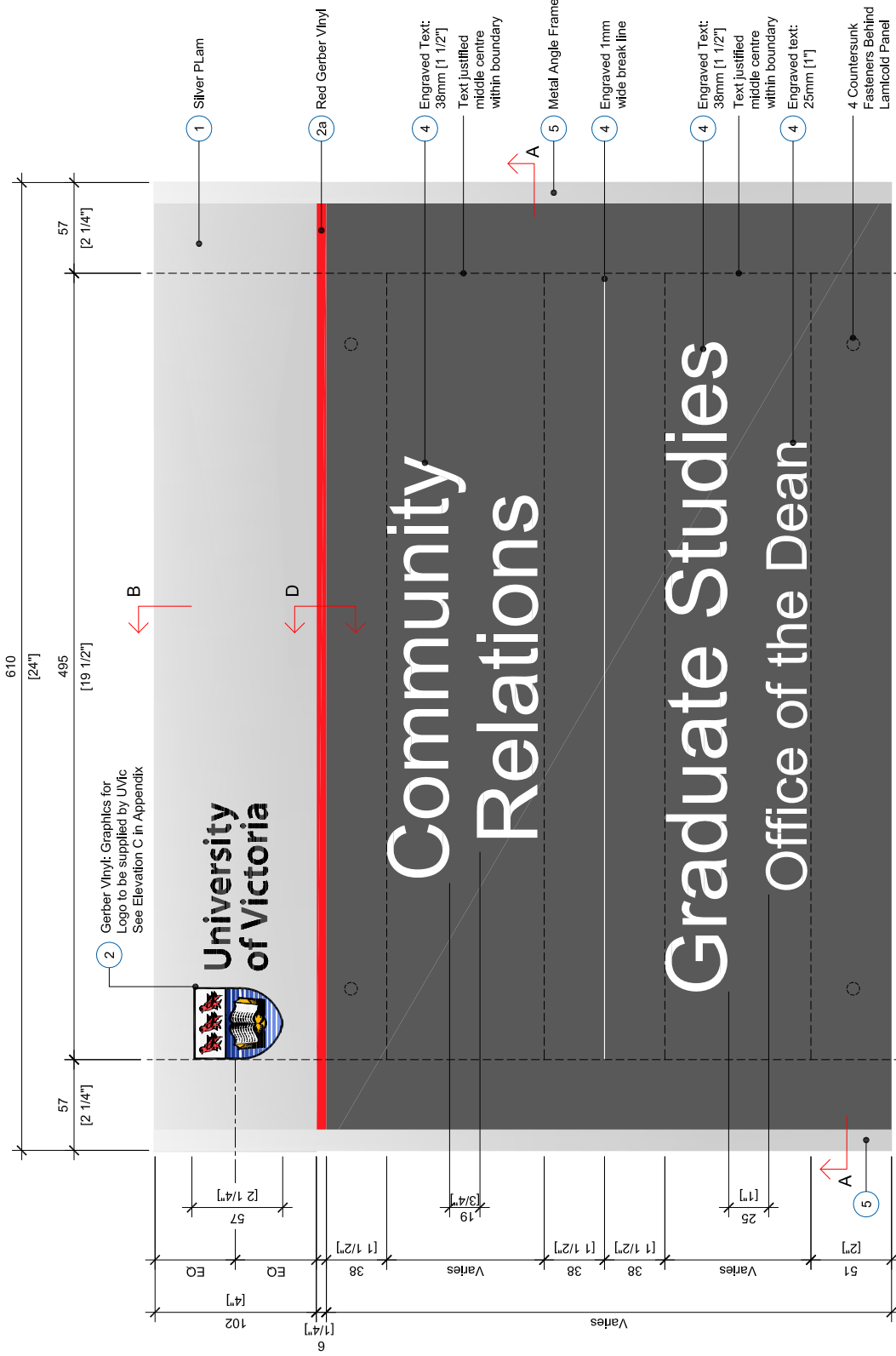

DEP2c

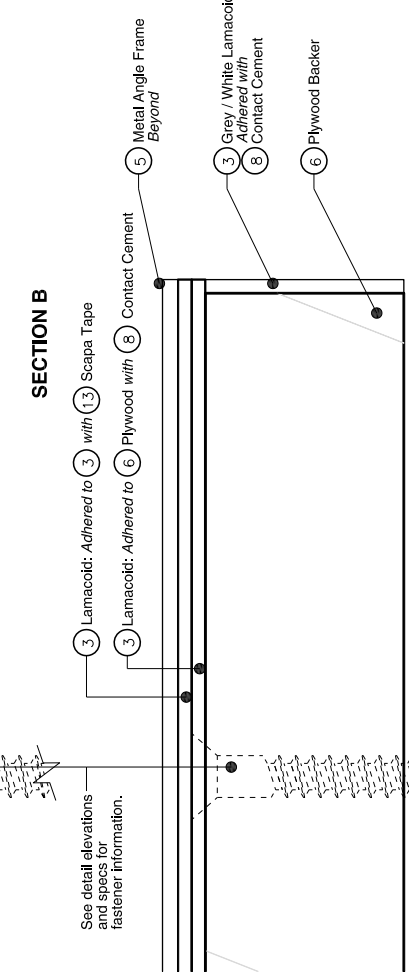
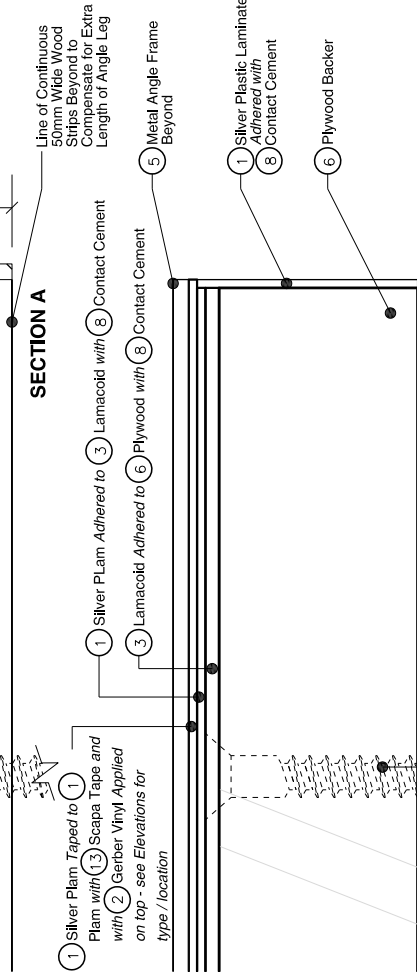
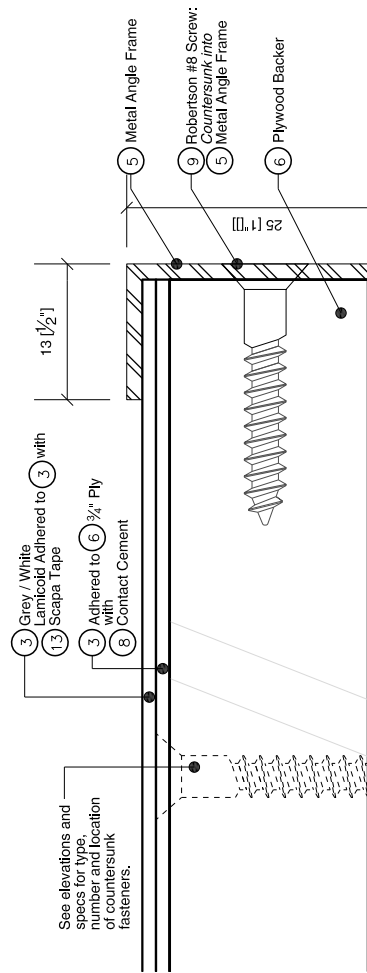
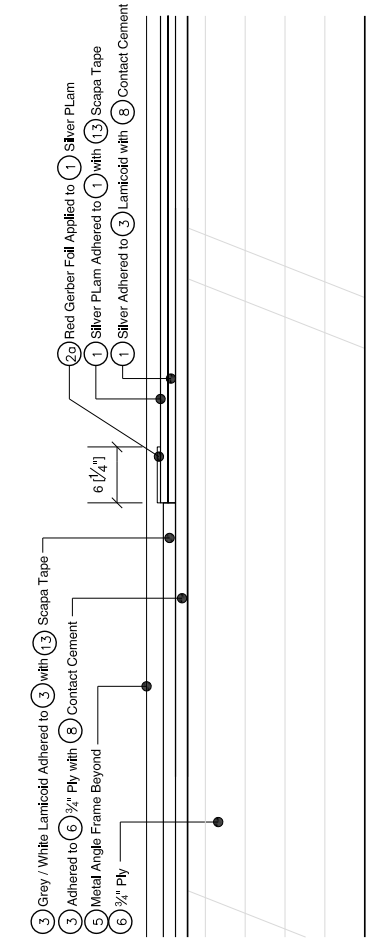

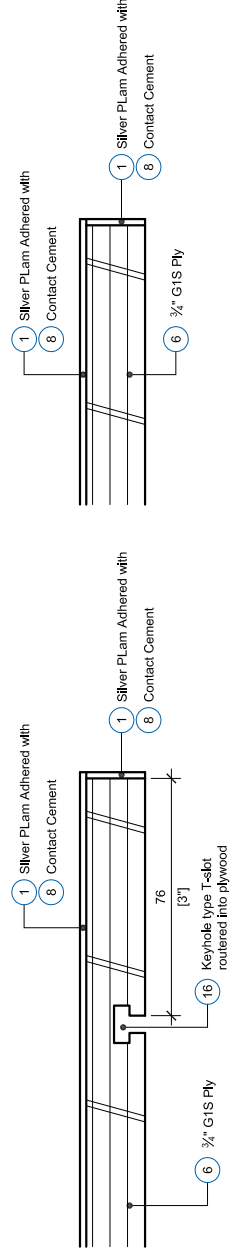
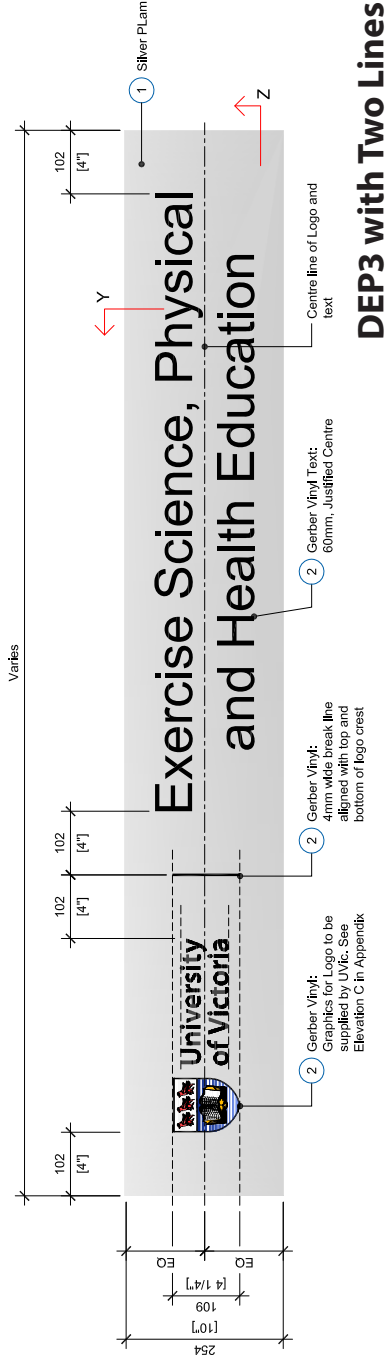
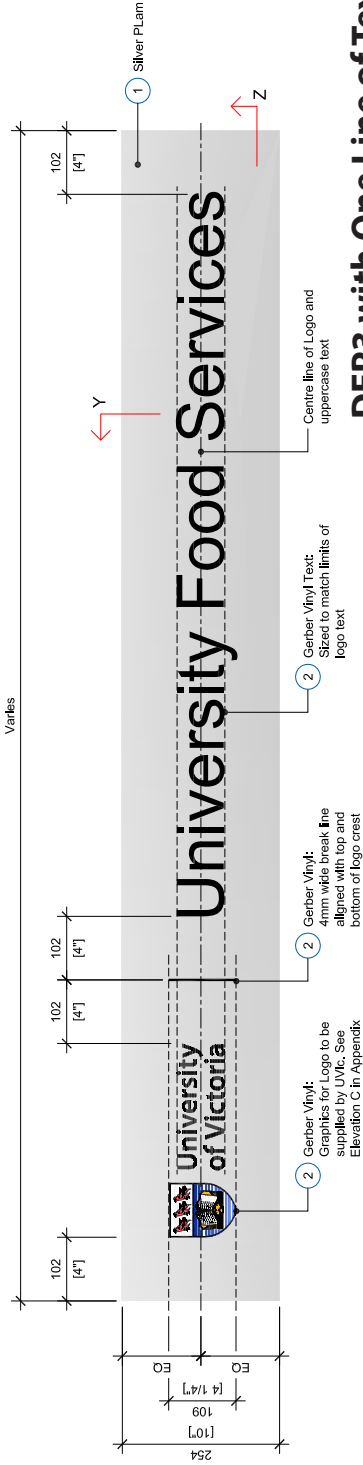

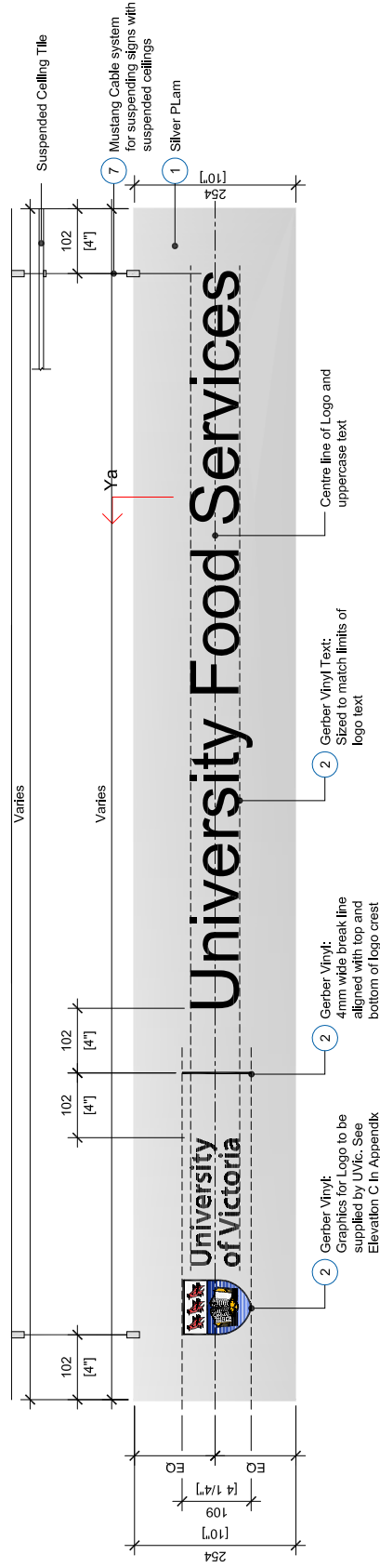

DEP3a

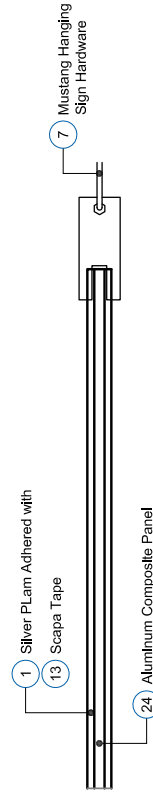

Section Ya

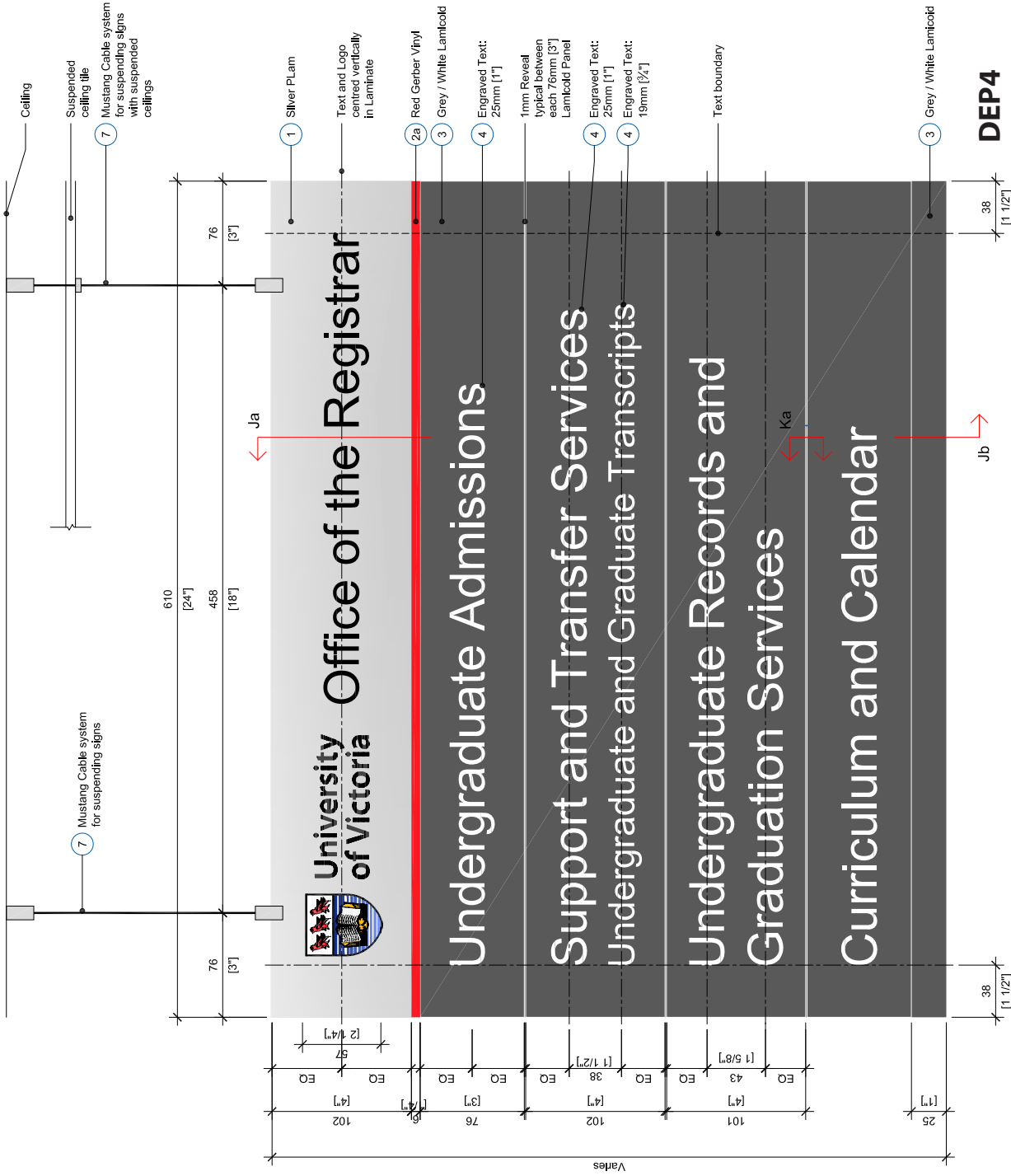

DEP4

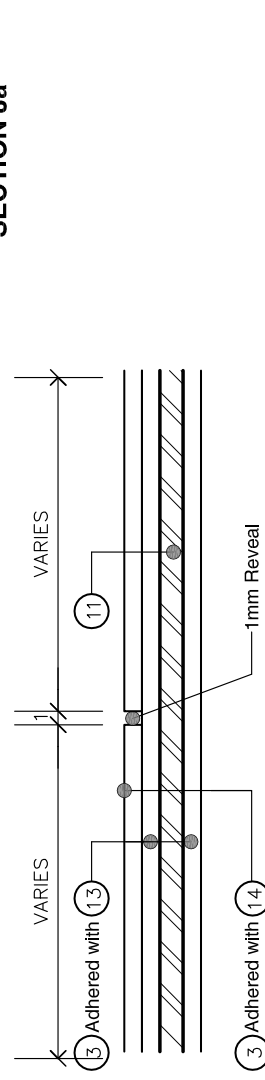
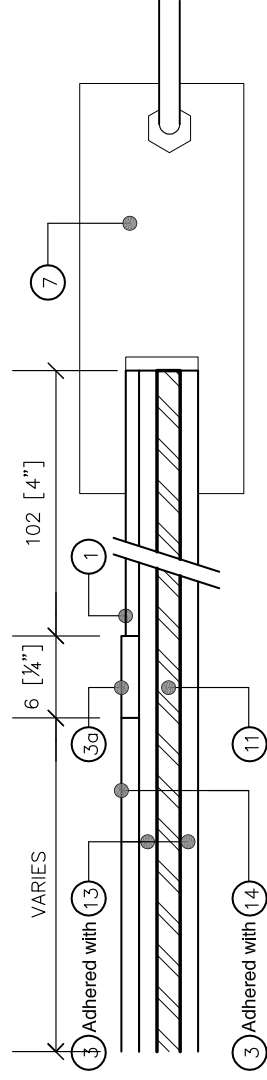
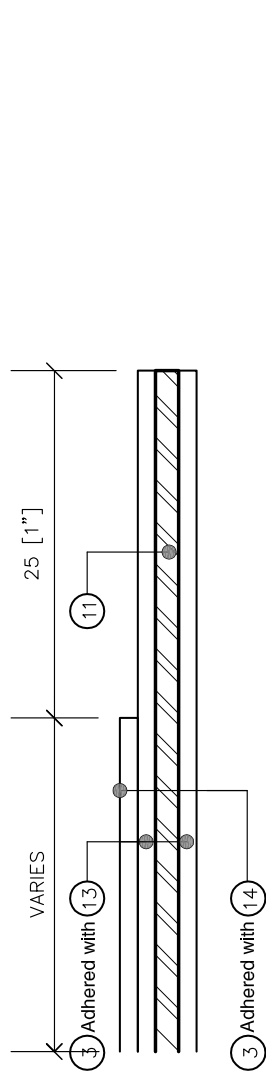



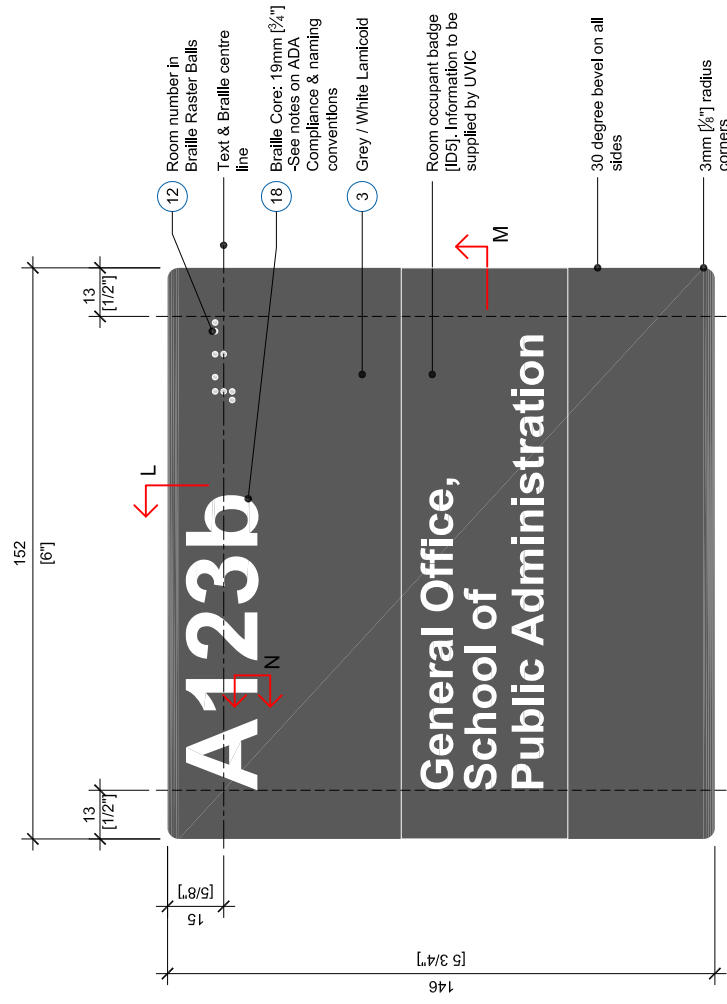

ID1a  
w/ ID5

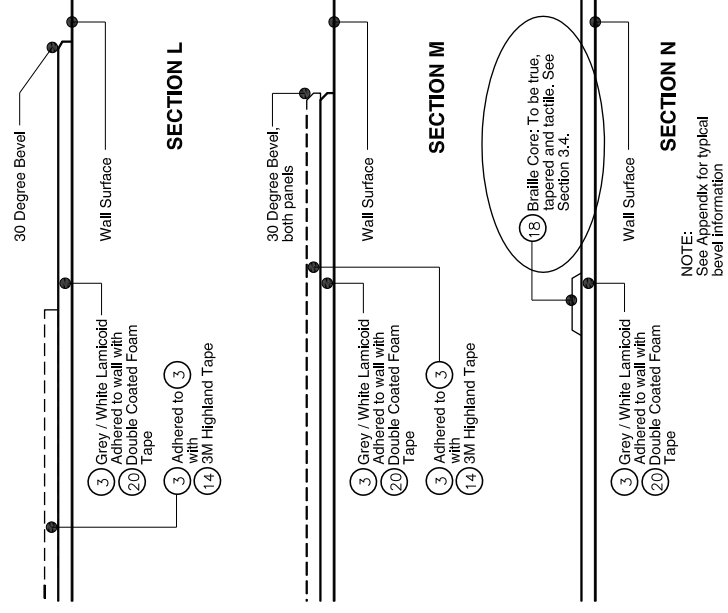

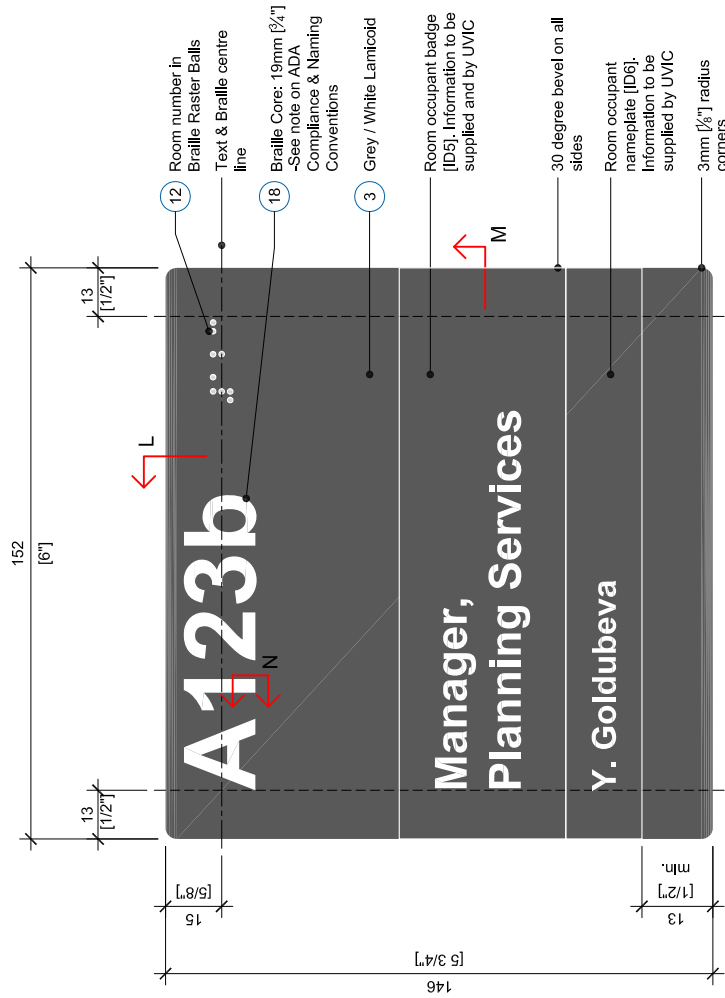

**ID1a**  
w/ ID5 & ID6

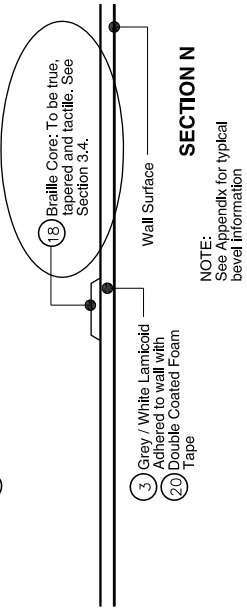
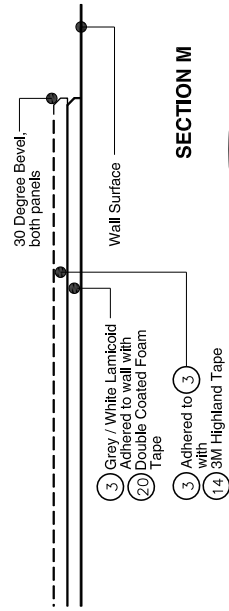
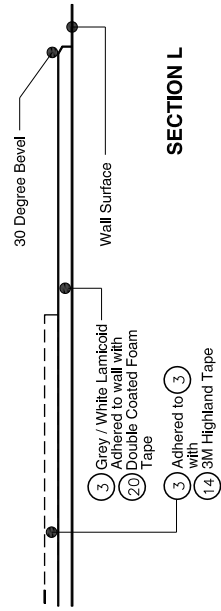

NOTE:  
See Appendix for typical  
bevel information

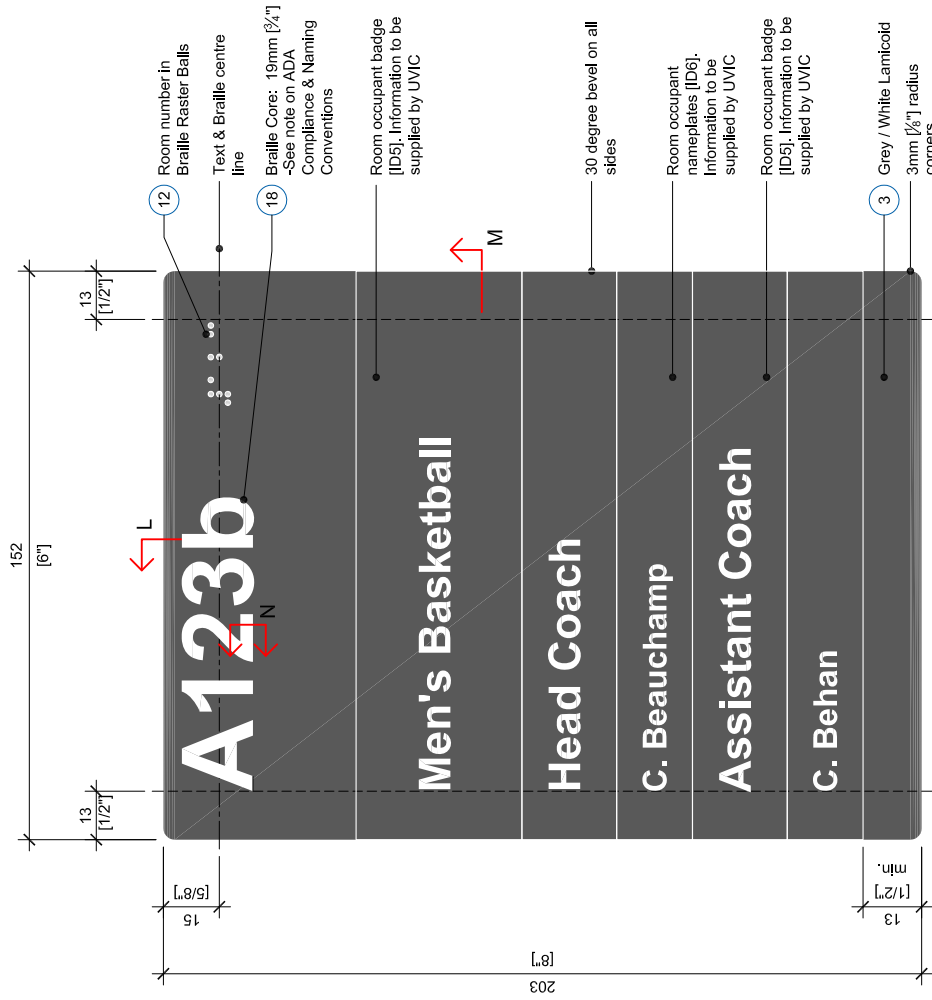

ID1b

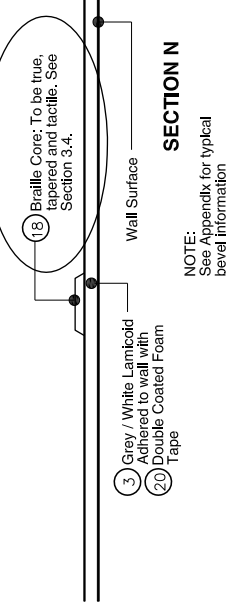
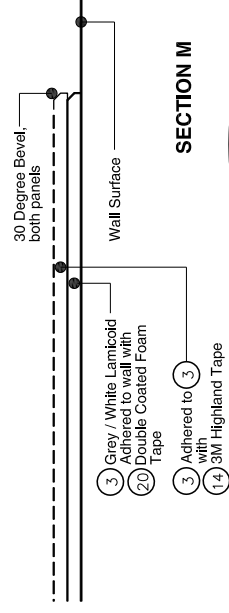
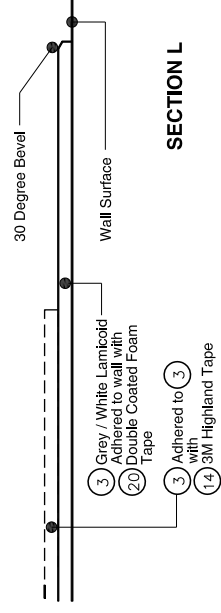

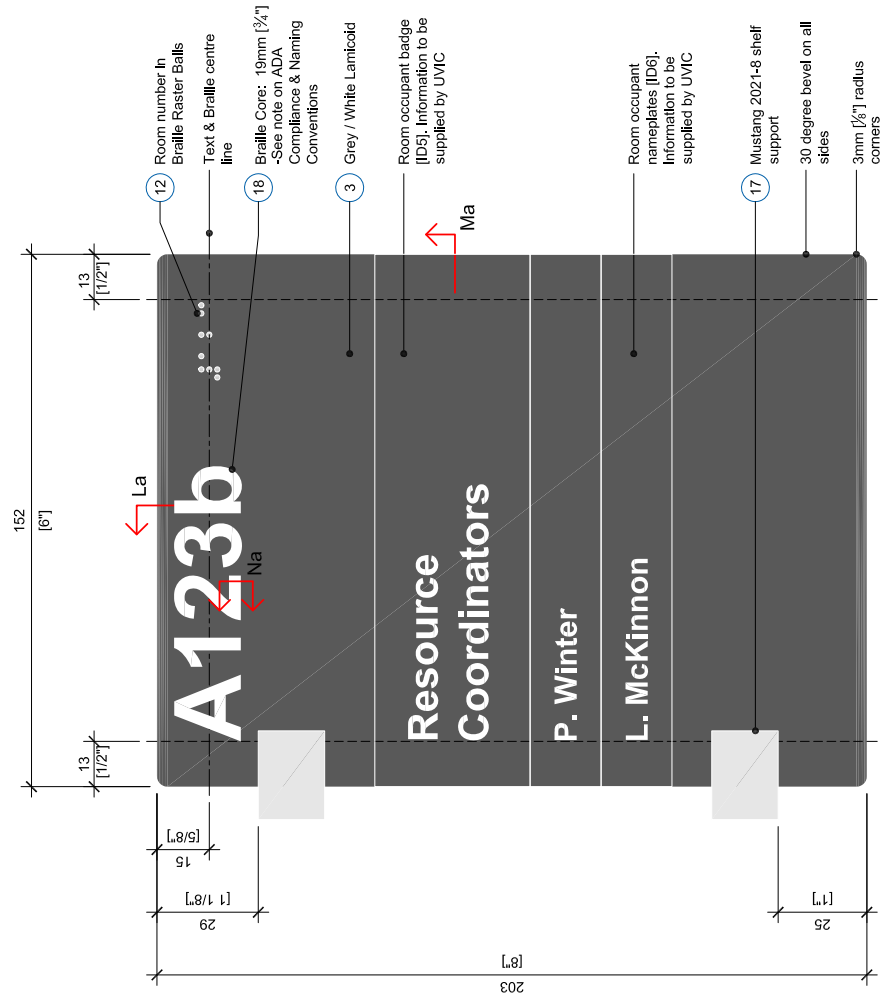

ID1c - Front

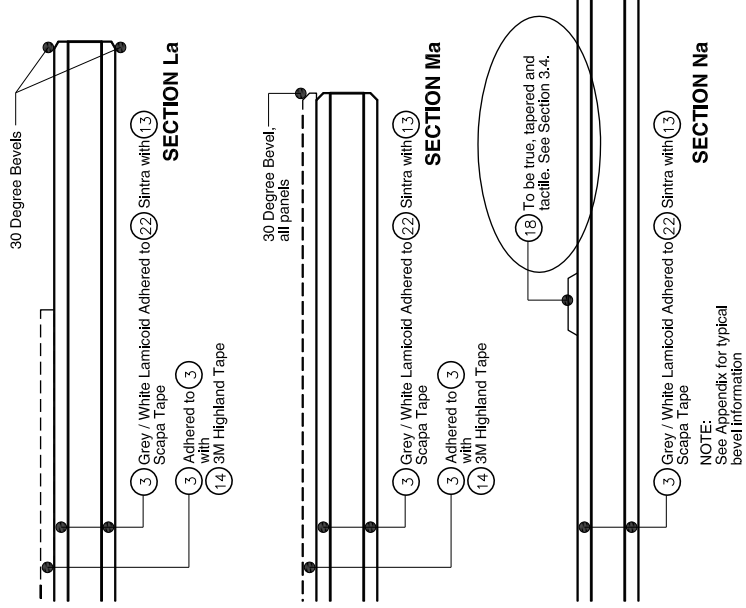

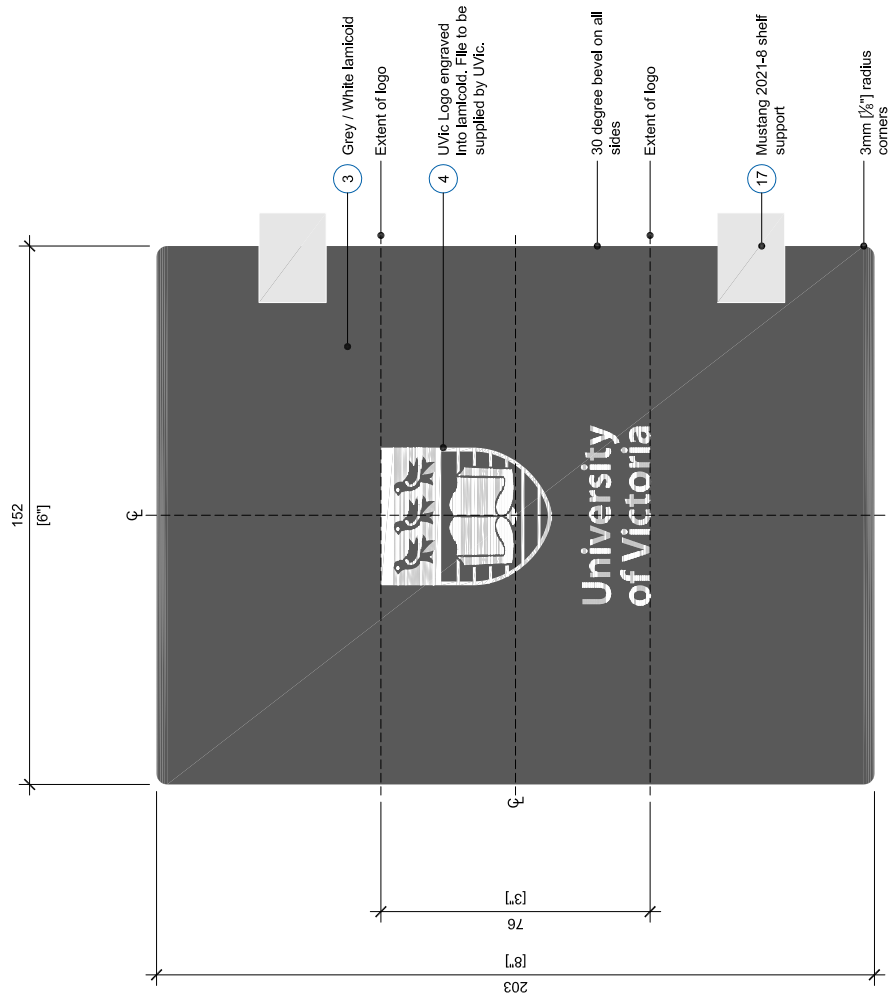

ID1c - Back

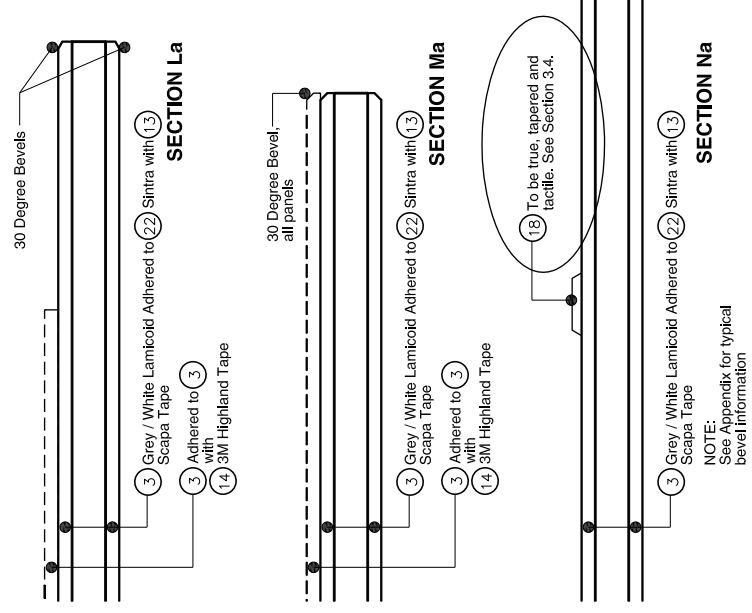
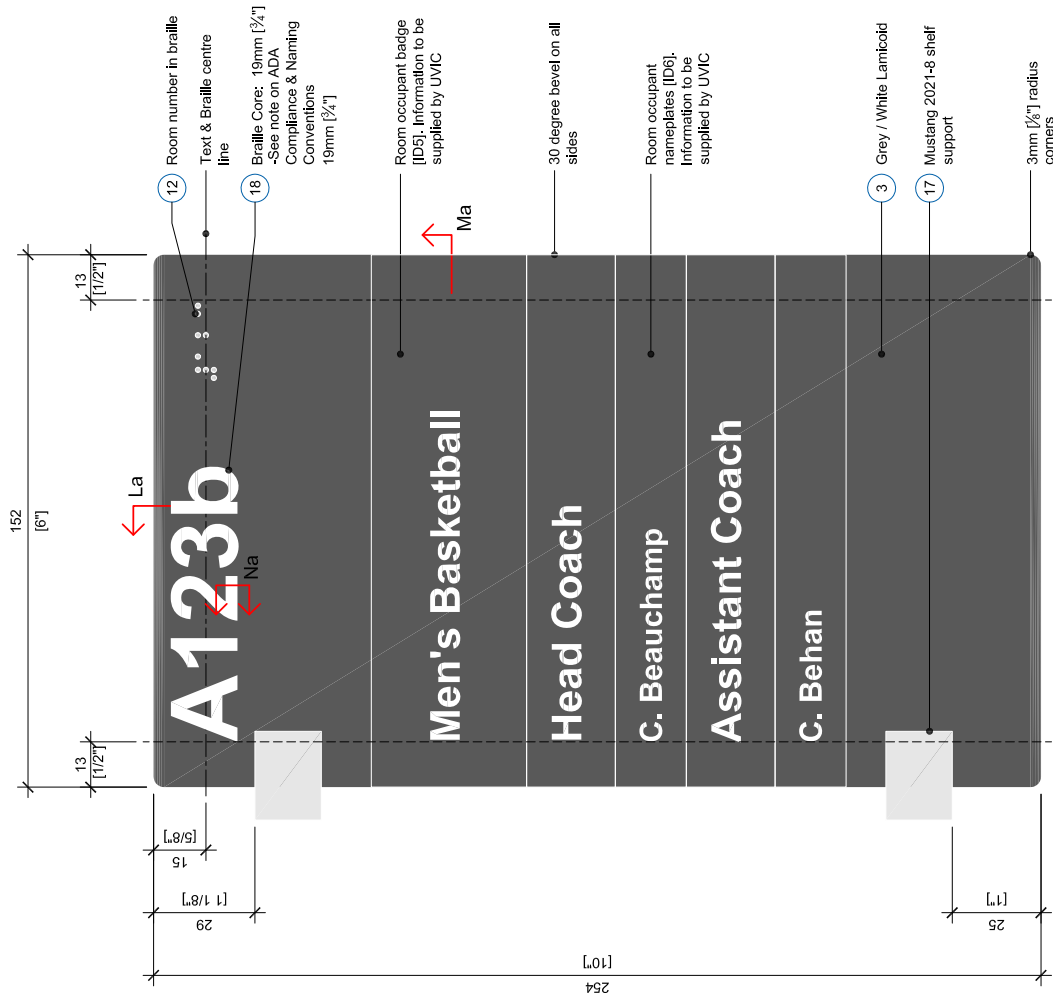

ID1d - Front

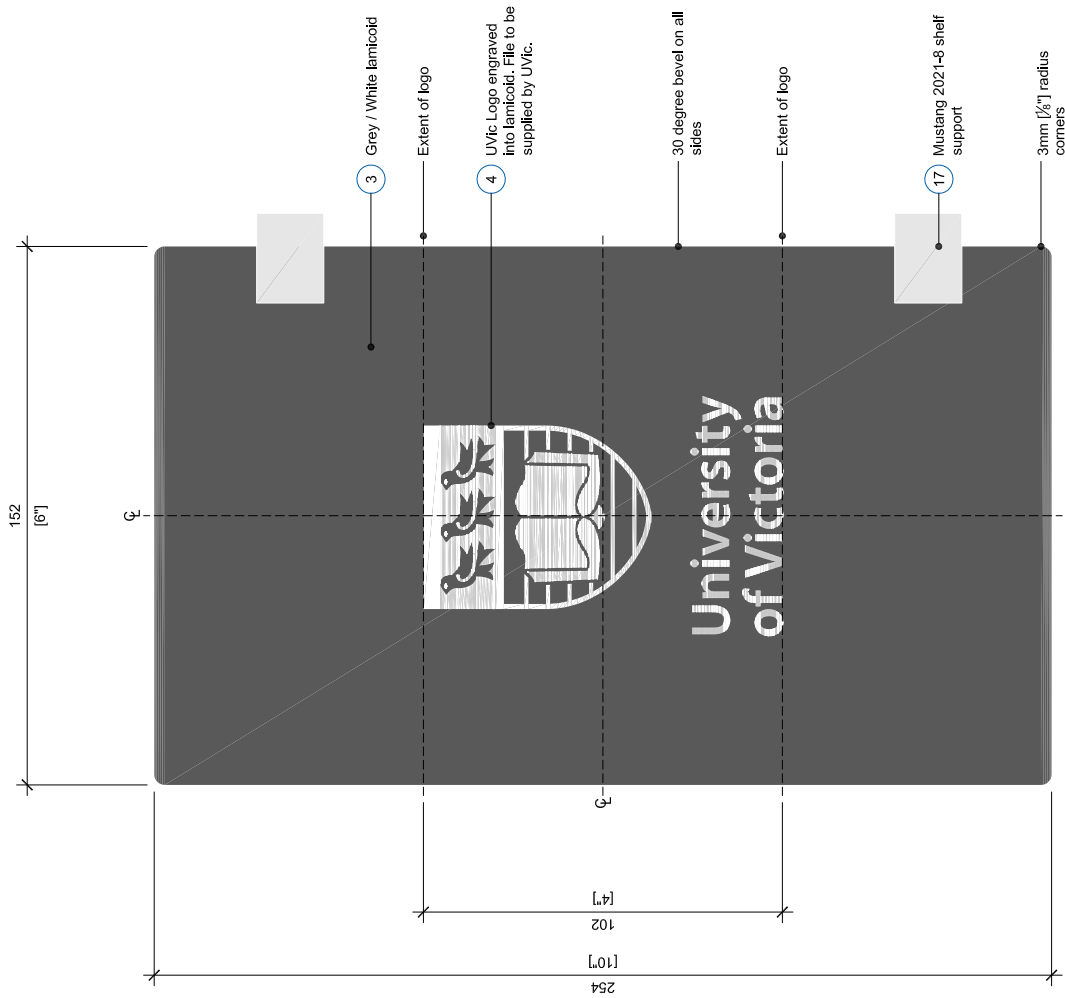

ID1d - Back

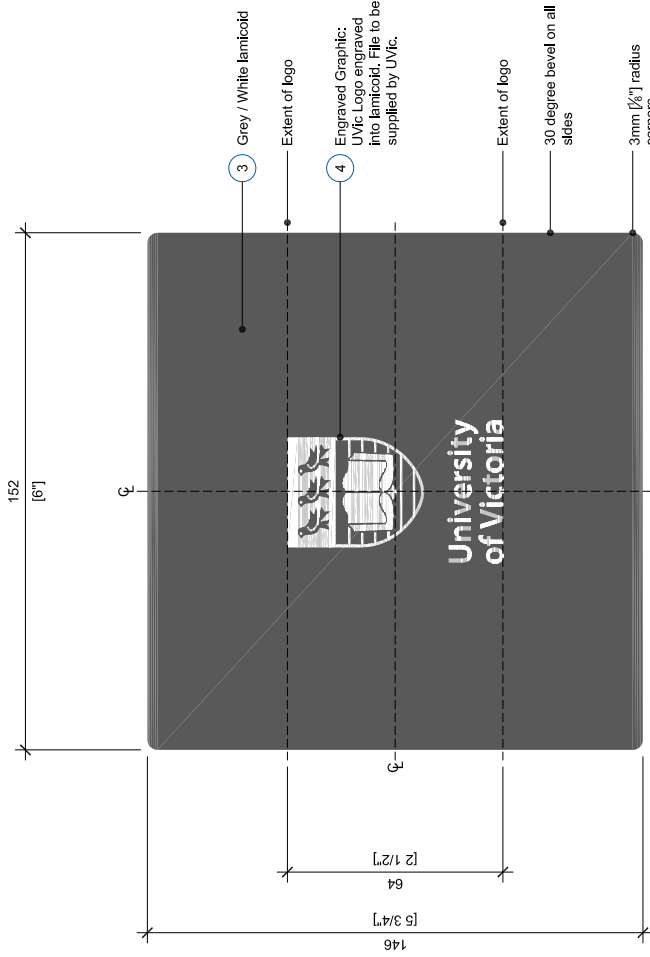

ID1r

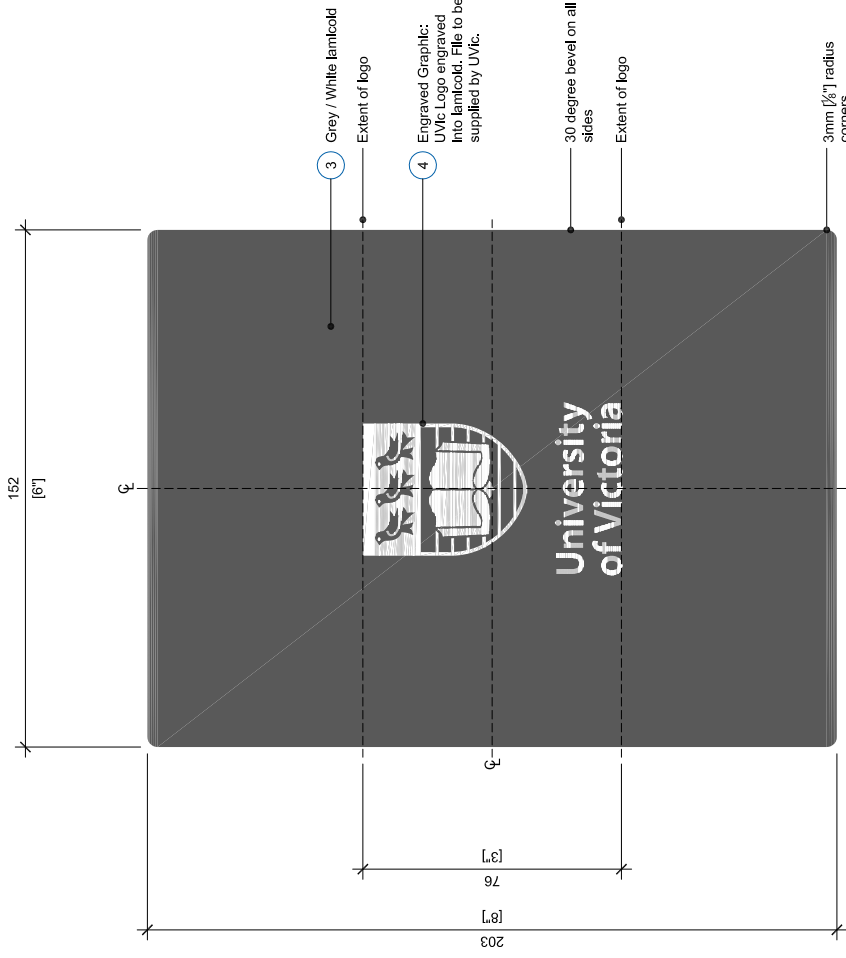

ID1s



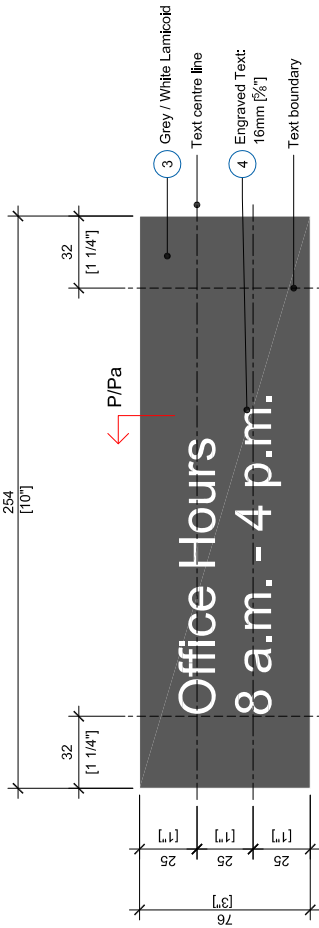

**ID2**

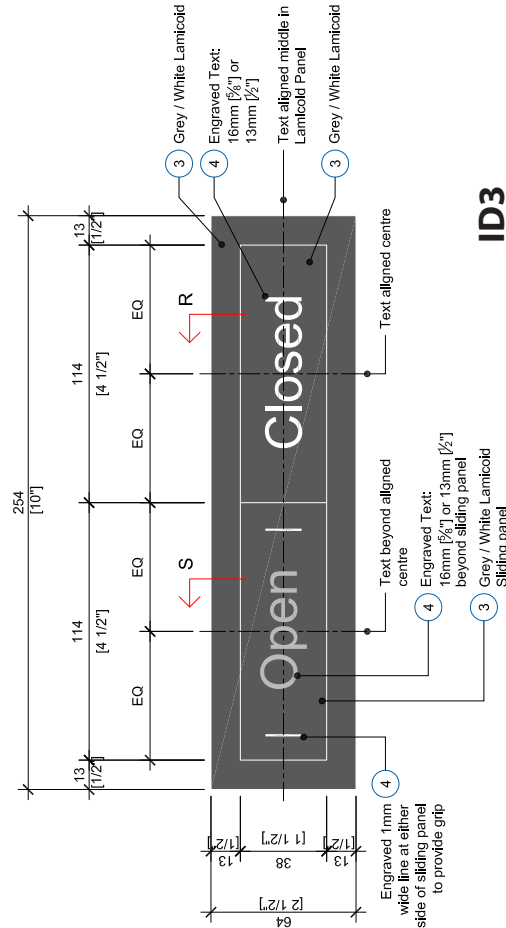

**ID3**

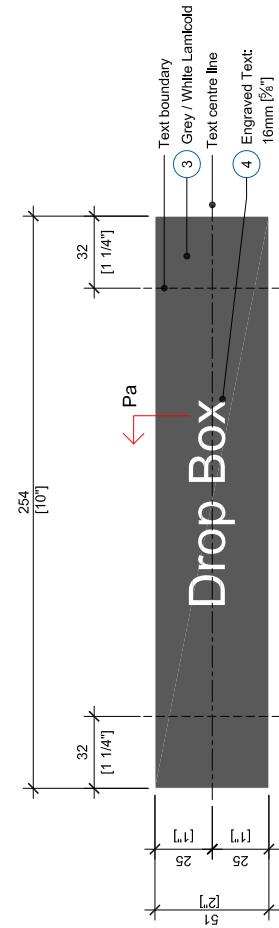

**ID4**

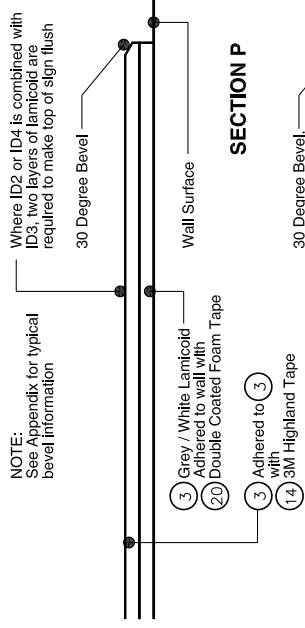

**SECTION P**

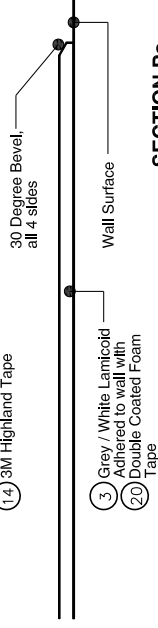

**SECTION Pa**

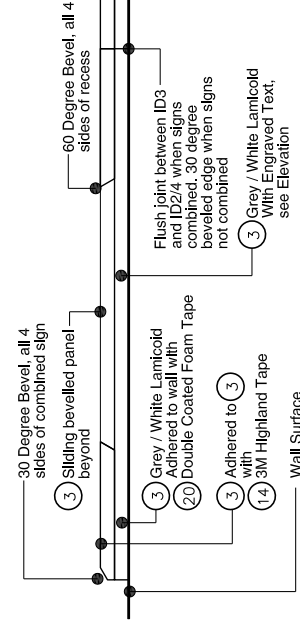

**SECTION R**

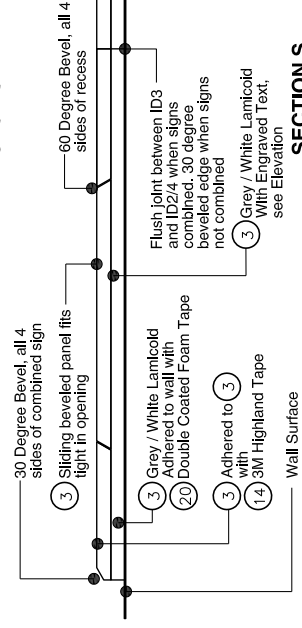

**SECTION S**

NOTE:  
See Appendix for typical bevel information

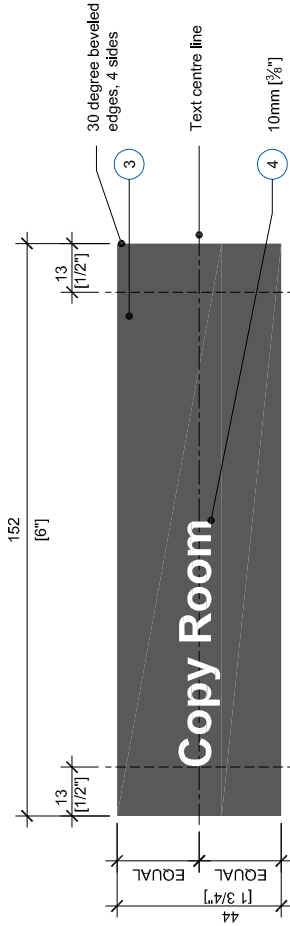

**ID5a**

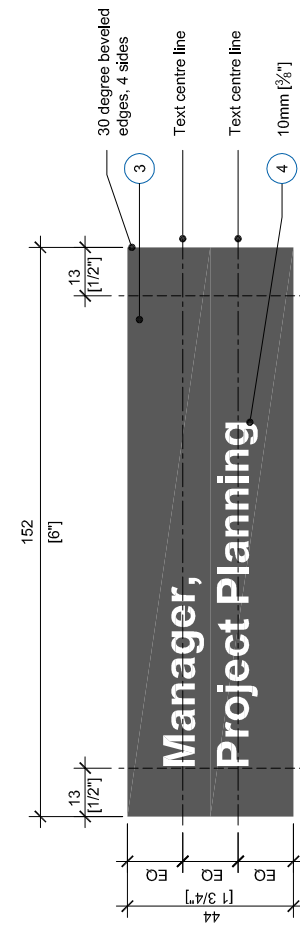

**ID5b**

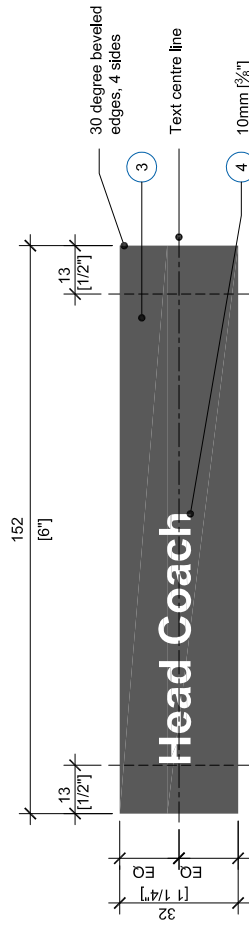

**ID5e**

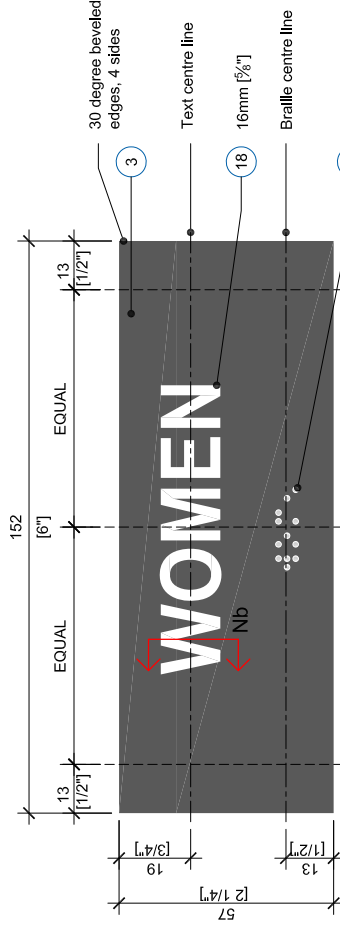

**ID5f**

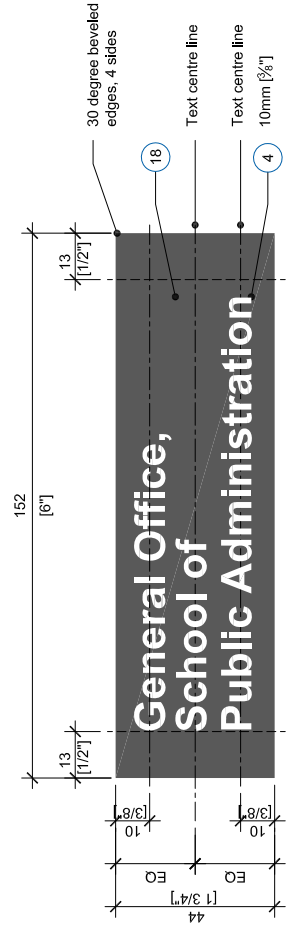

**ID5c**

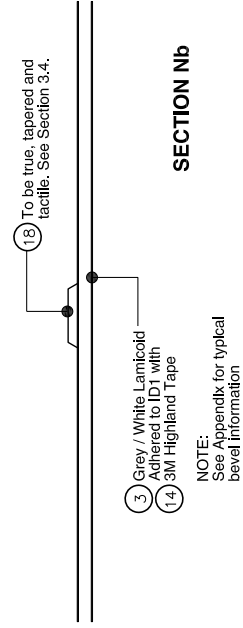

- 3 Grey / White Lenticoid Material to IDT with
  - 18 3M Highland Tape
- NOTE:  
See Appendix for typical Bevel Information

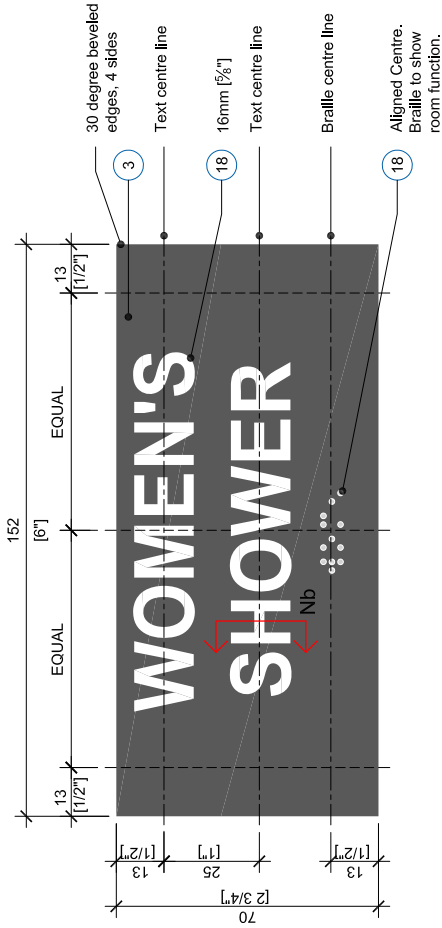

ID5g

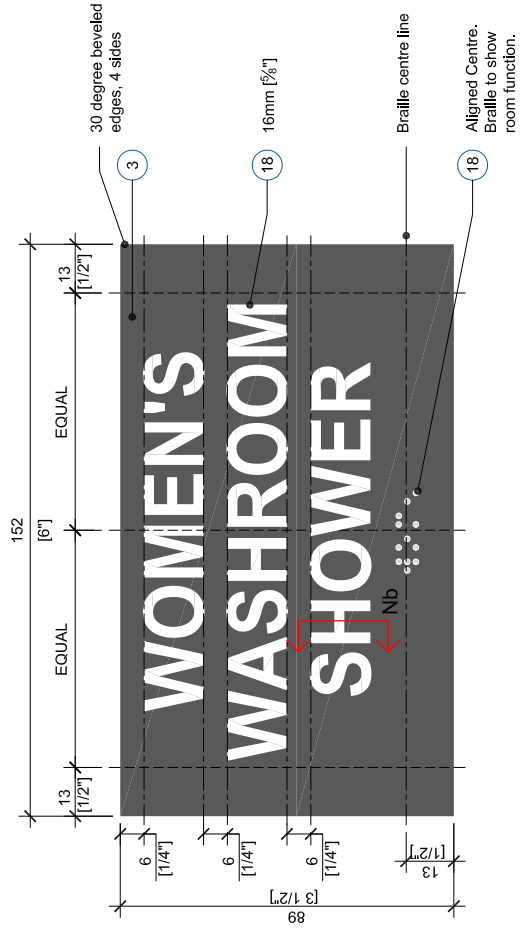

ID5h

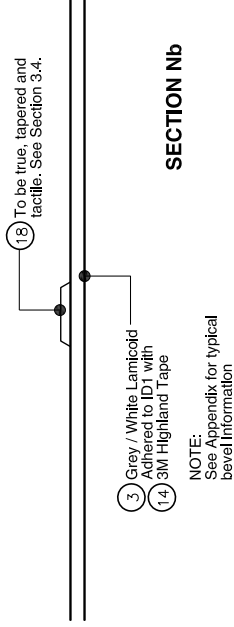

NOTE:  
See Appendix for typical bevel information

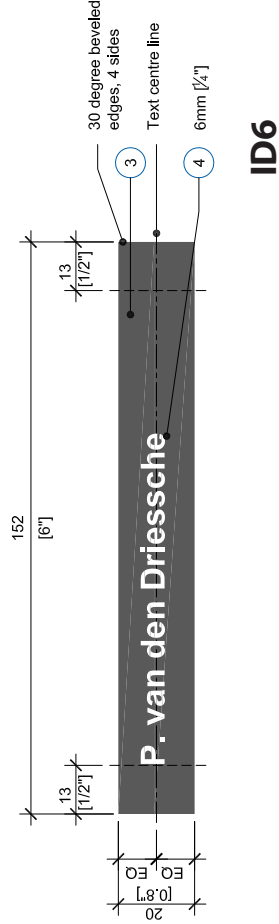

ID6

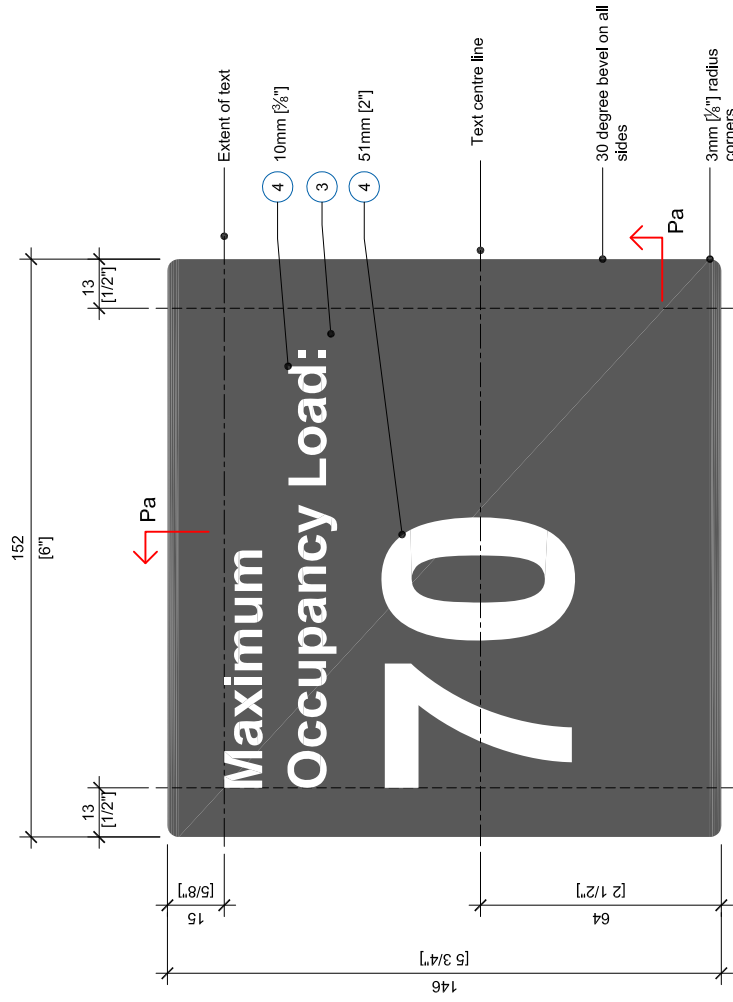

ID7

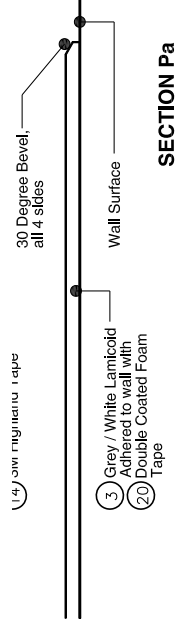

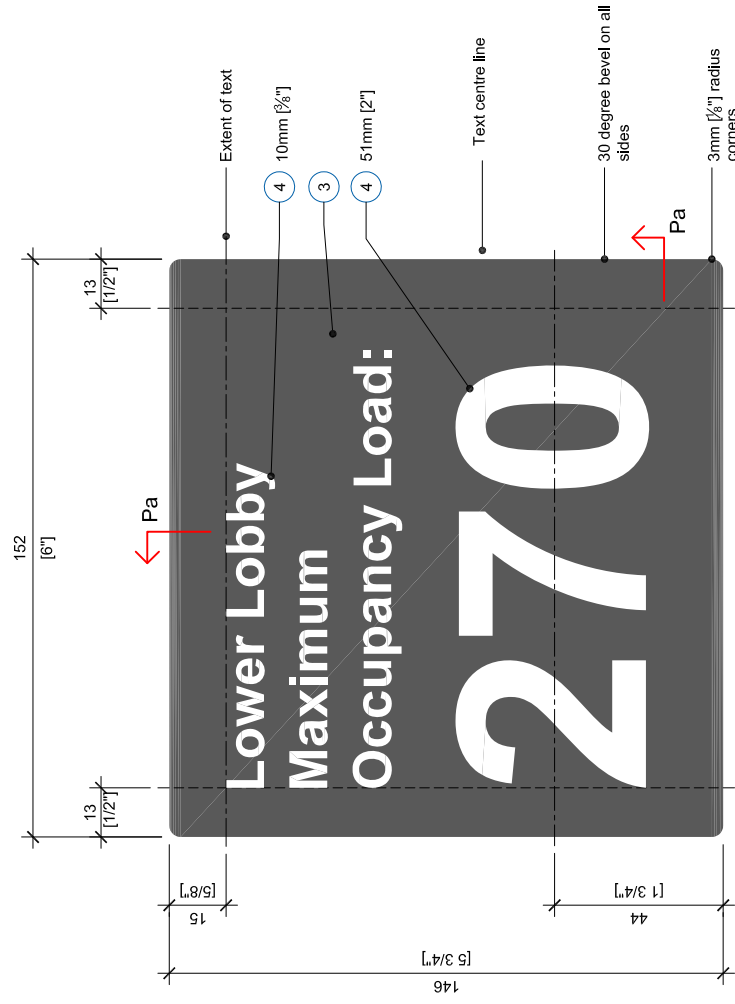

ID7a

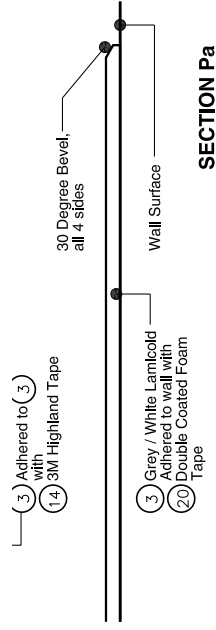





University of Victoria

Interior Wayfinding Signage Specifications and Details

# ROOM IDENTIFICATION [ID DETAILS]

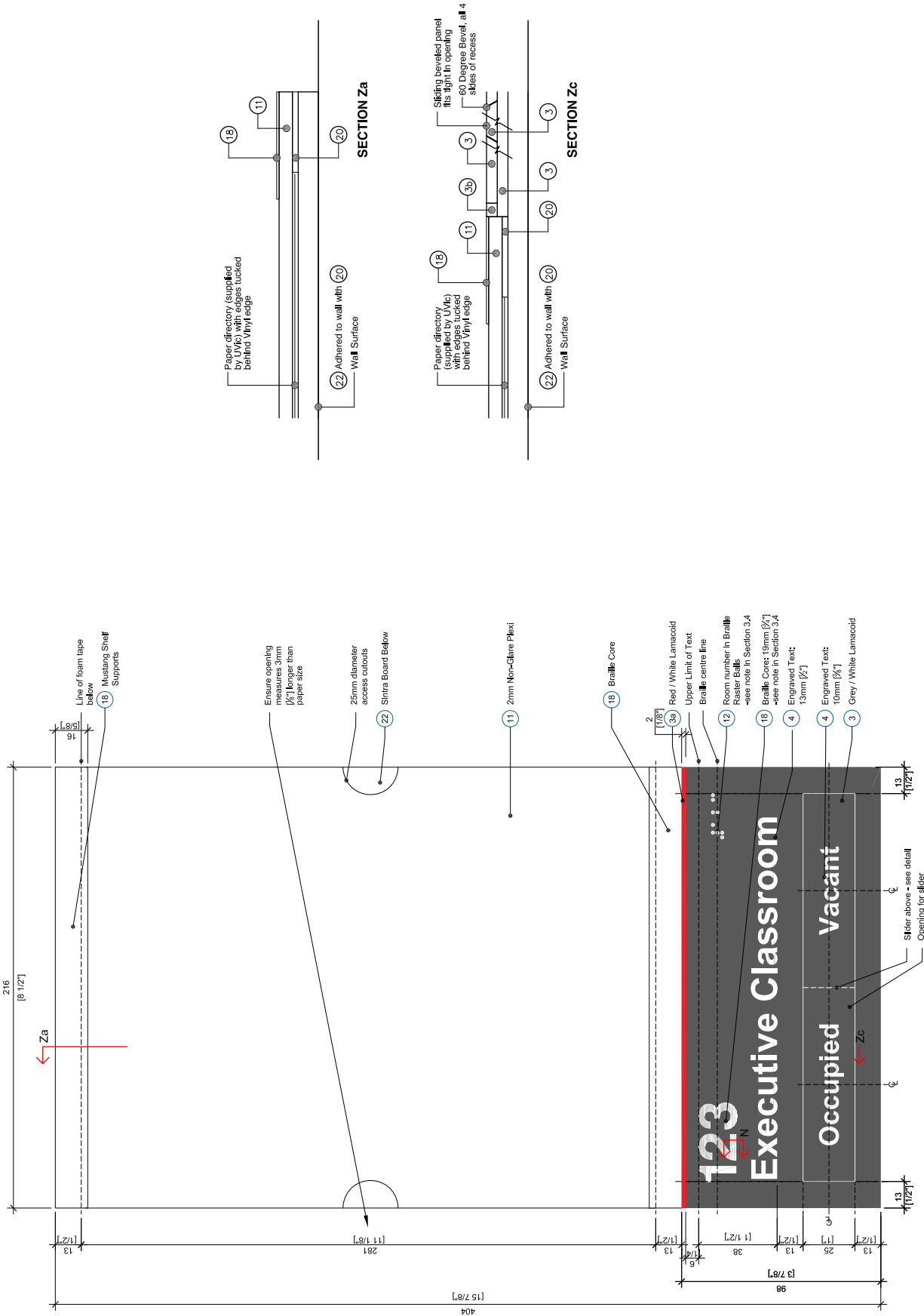

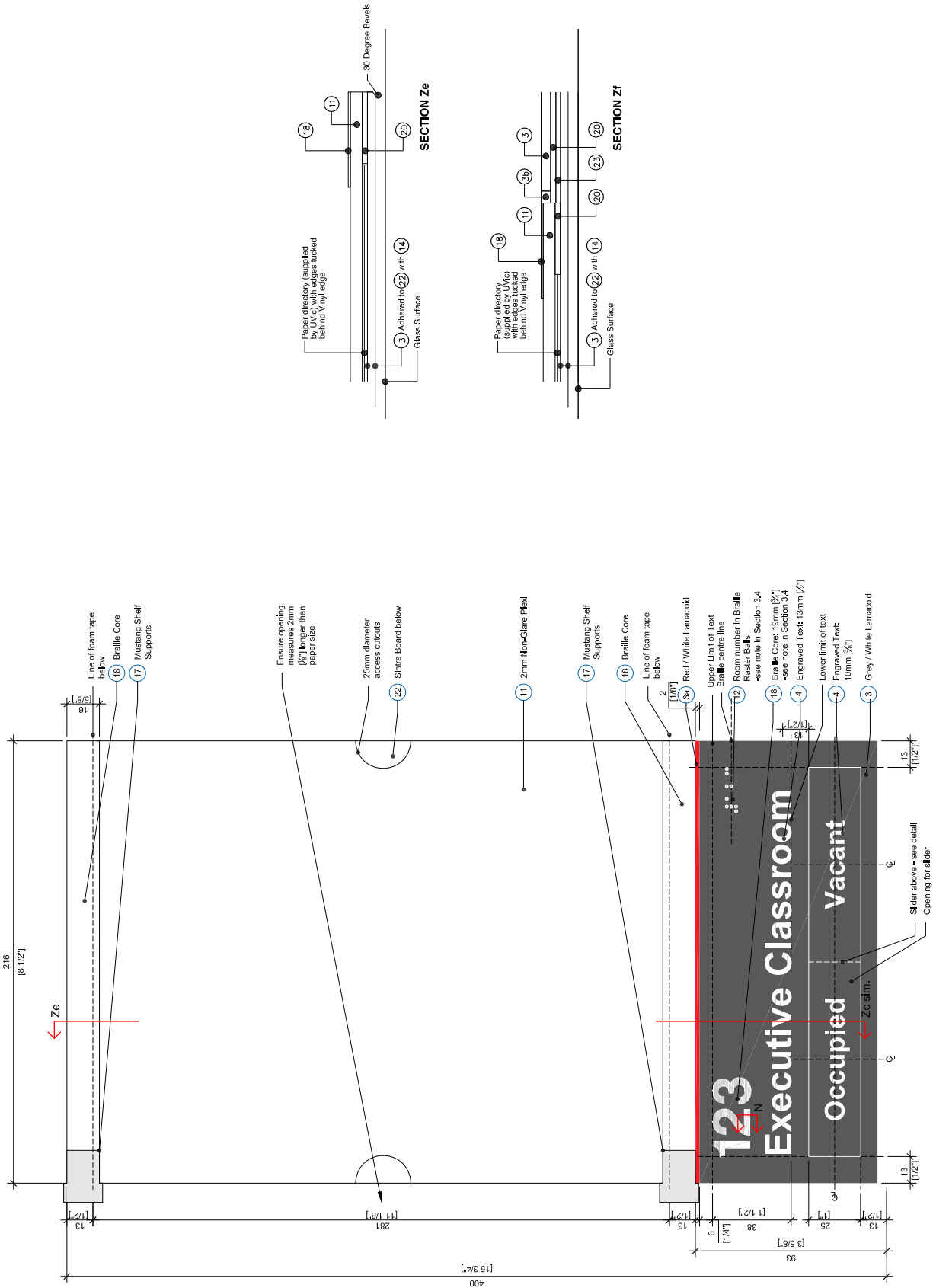



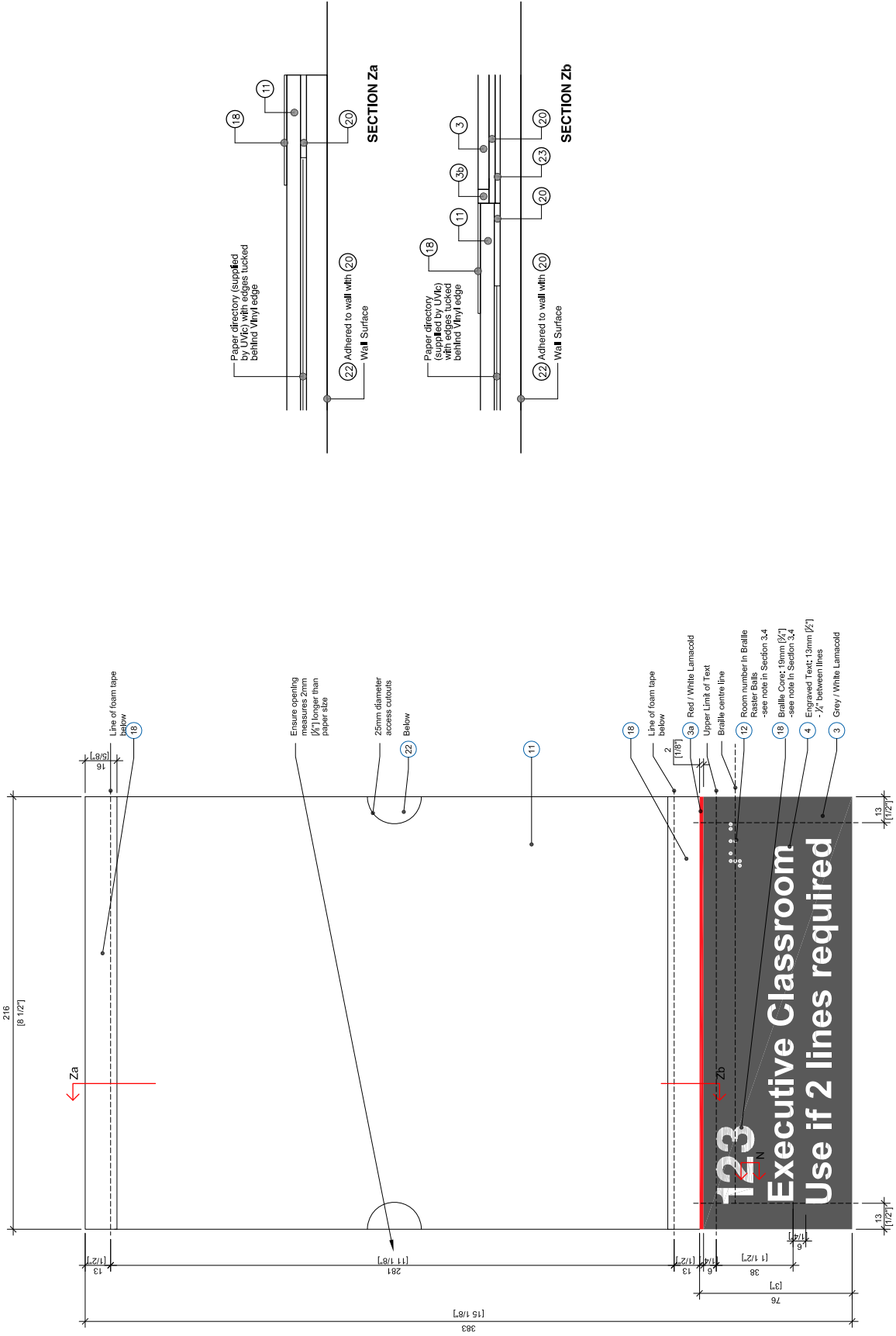

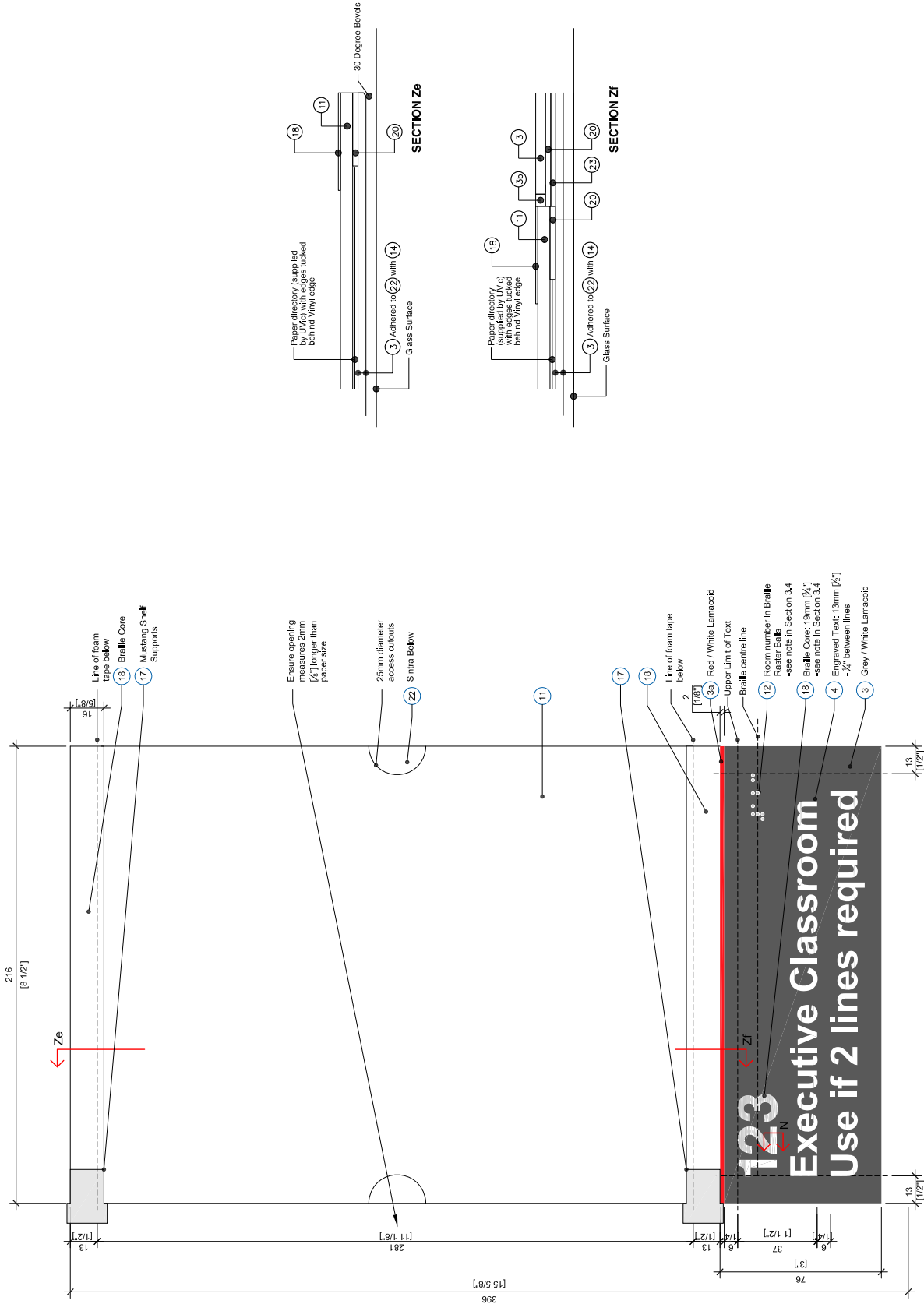

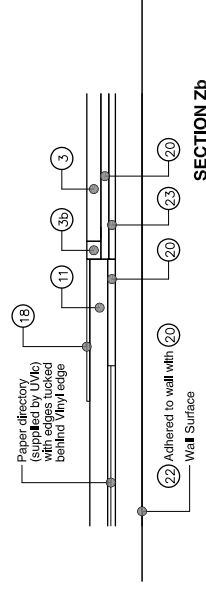
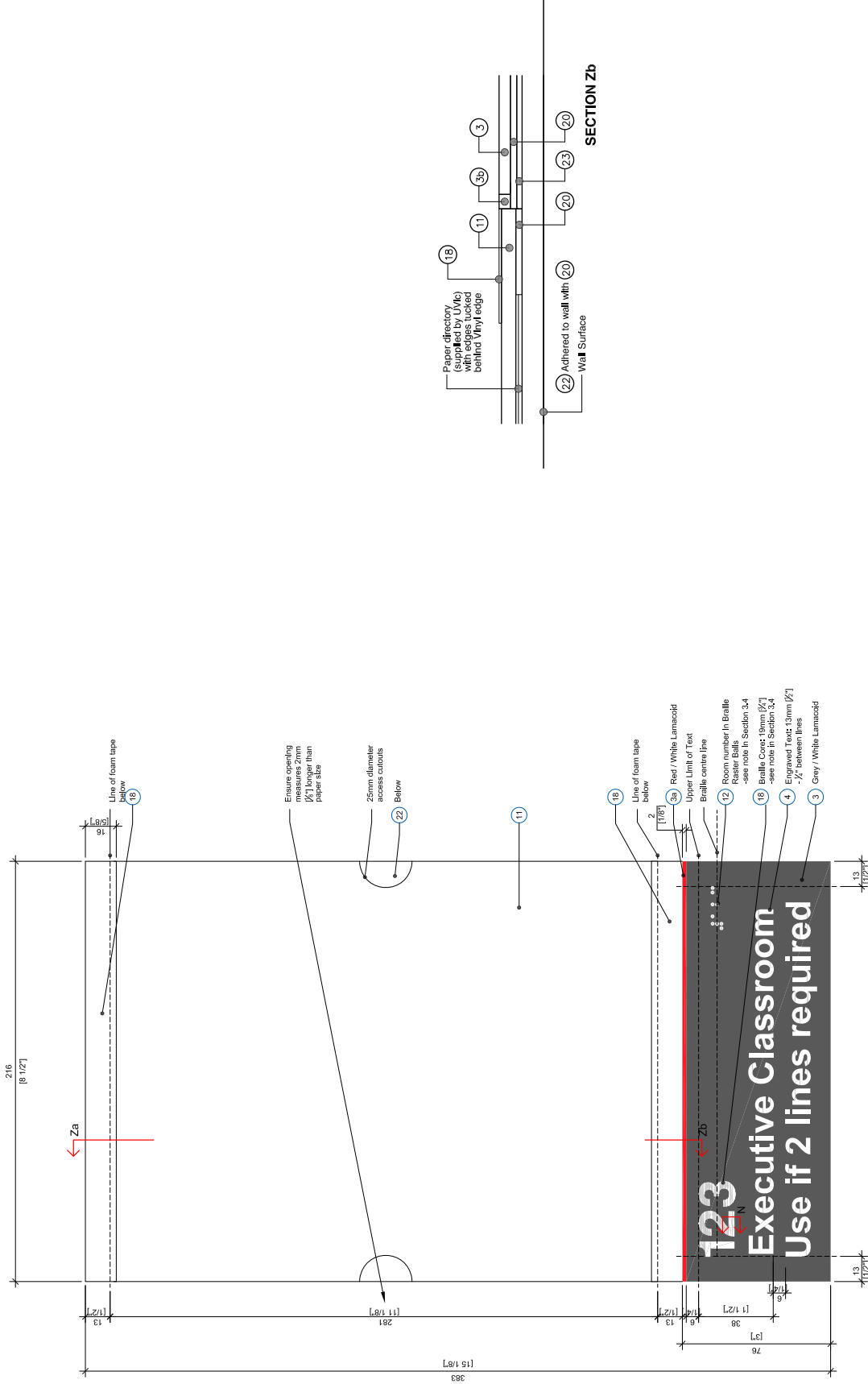

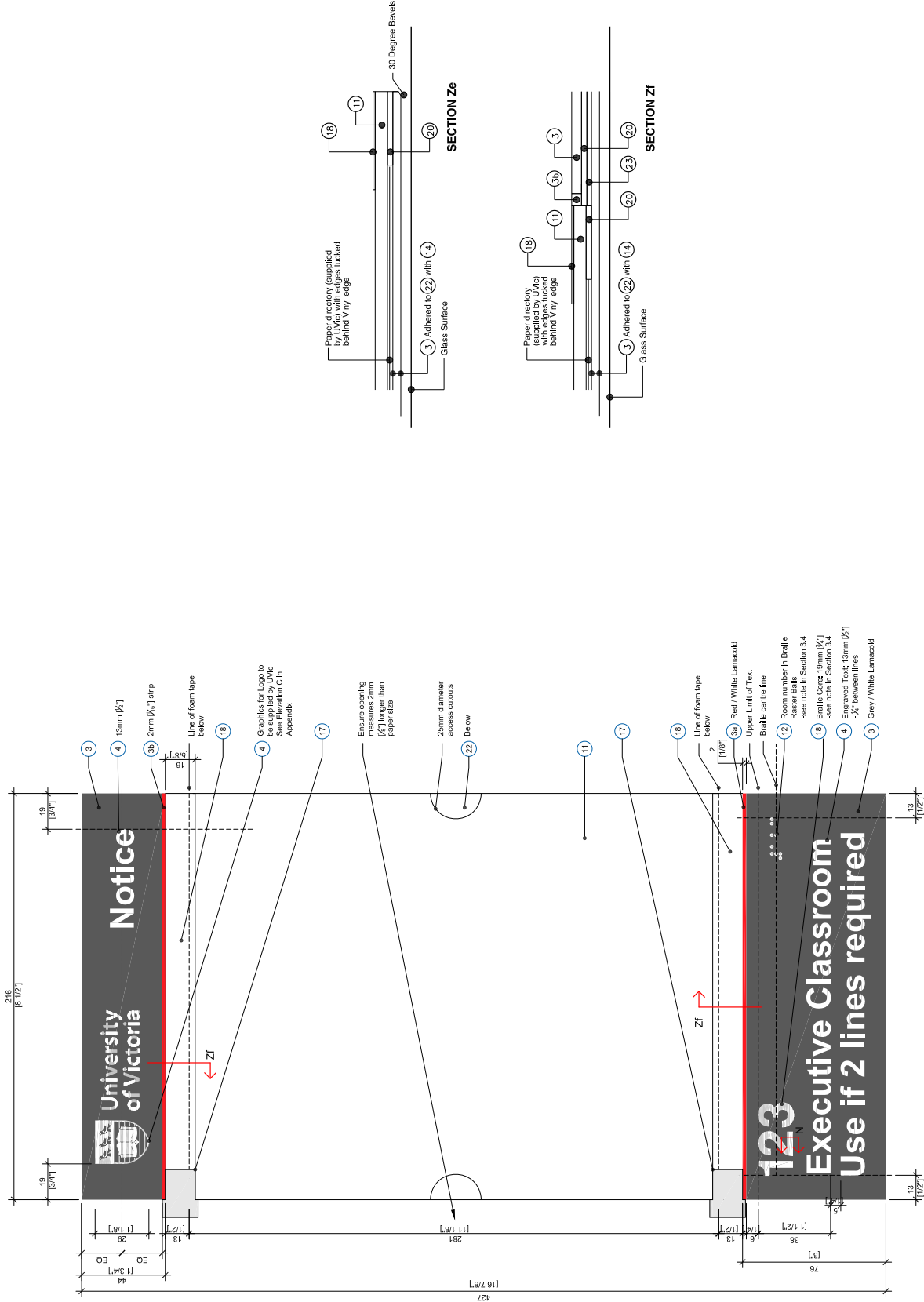

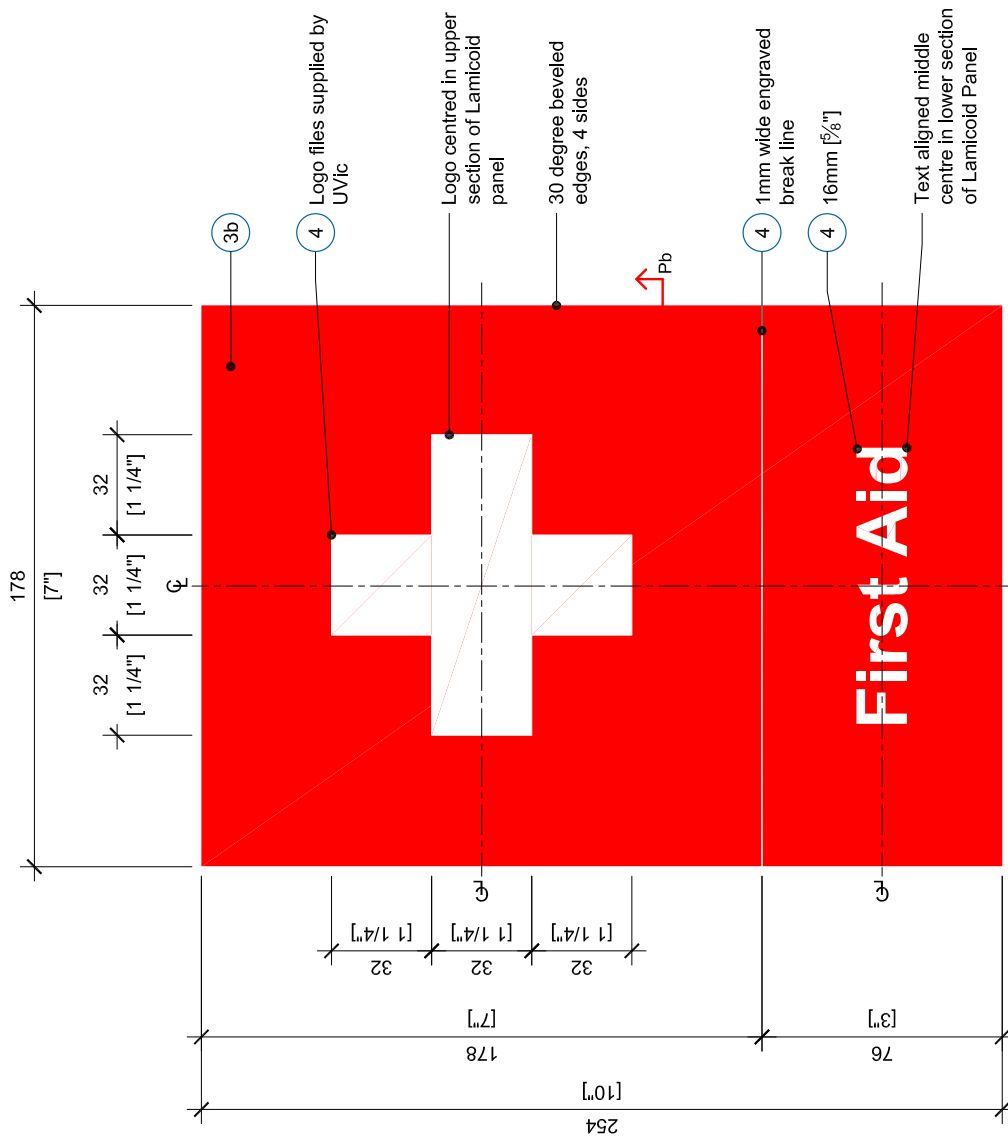

**ID10**

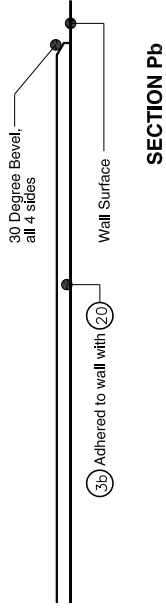

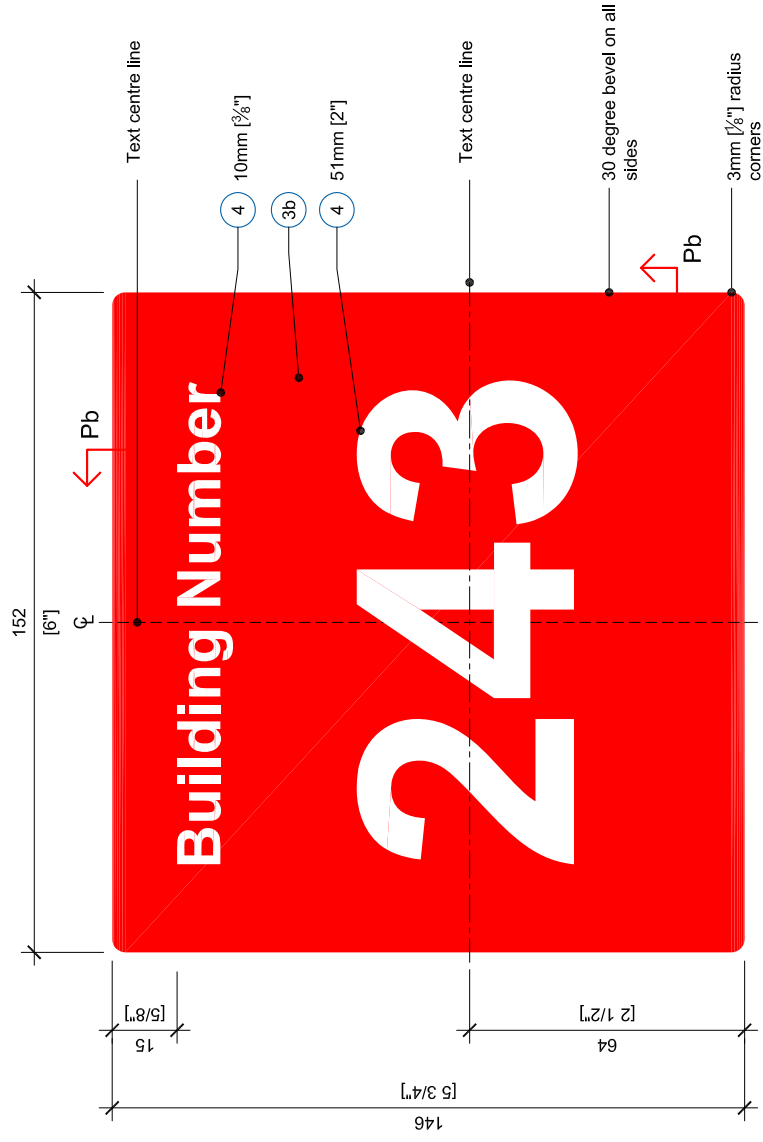

**ID11**

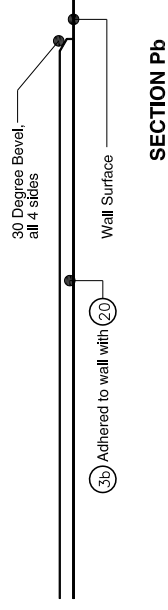

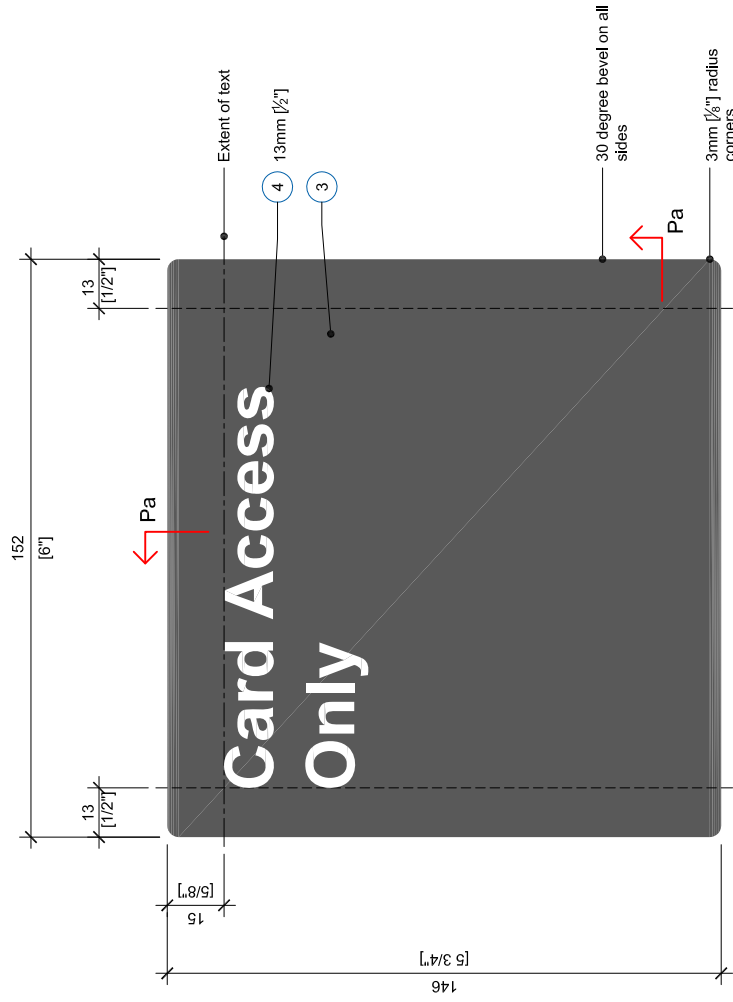

ID12

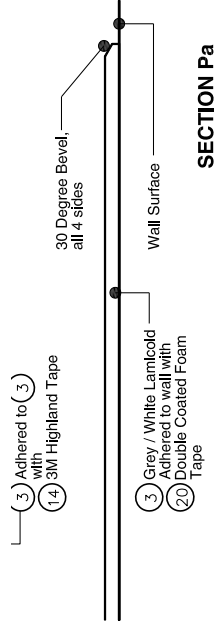

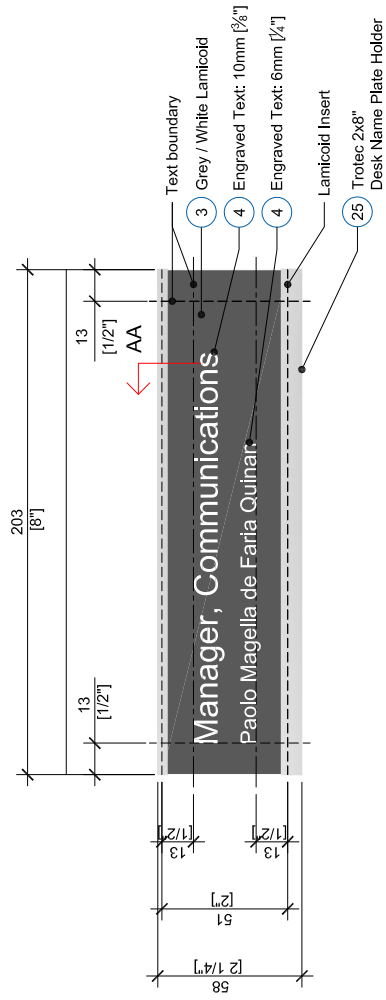

ID14a

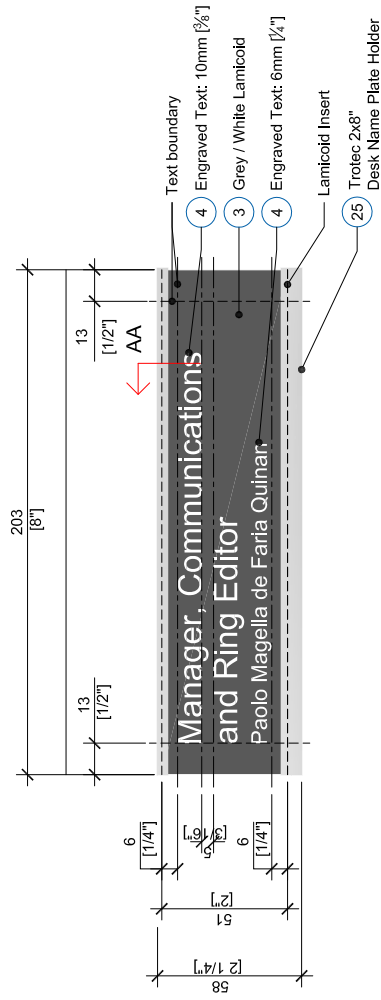

ID14b

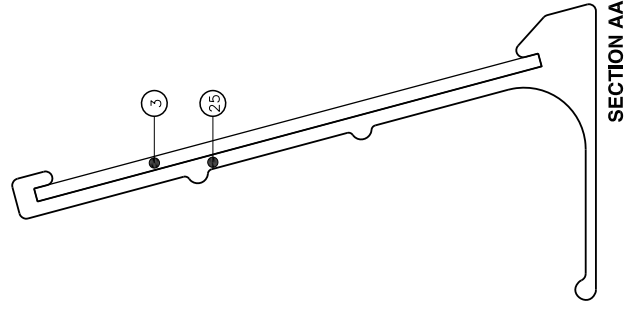



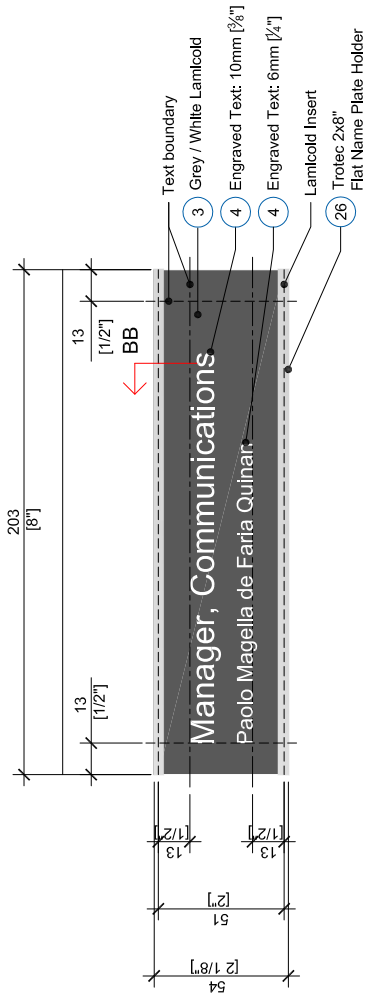

ID15a

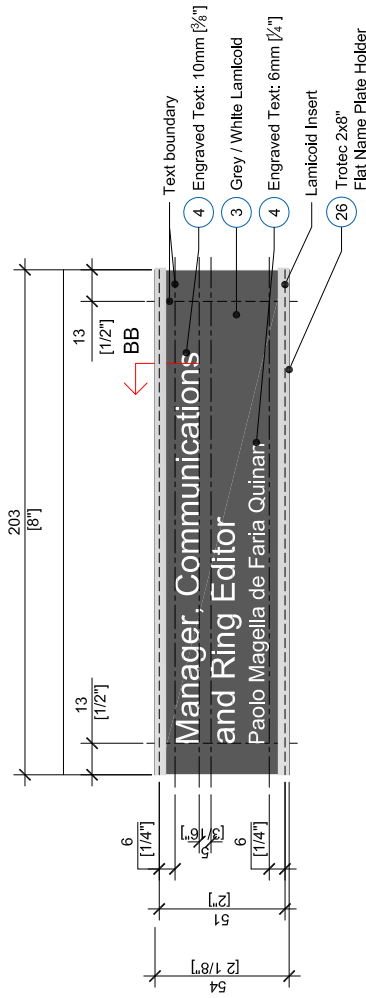

ID15b

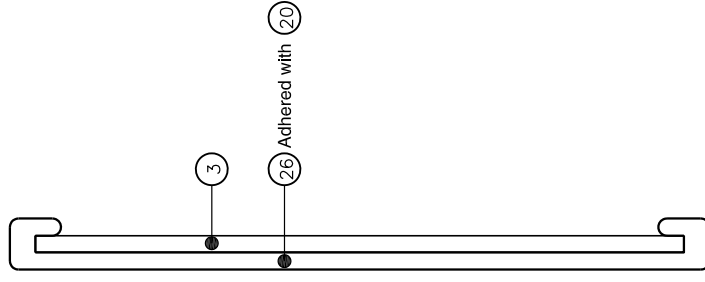

SECTION BB

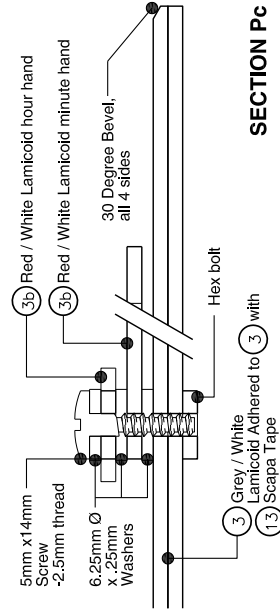
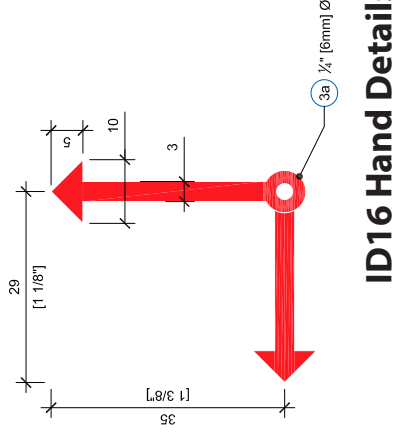
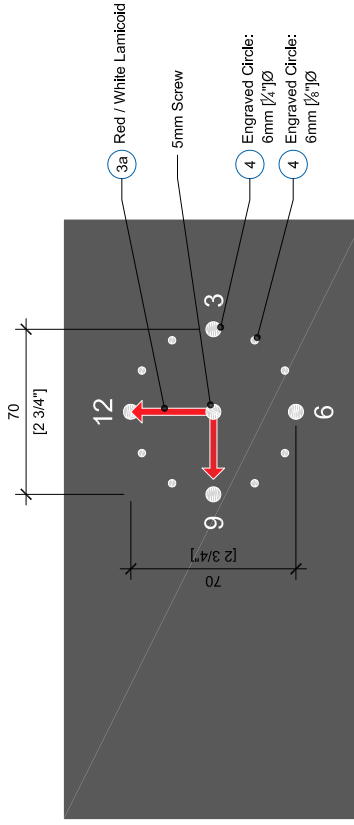
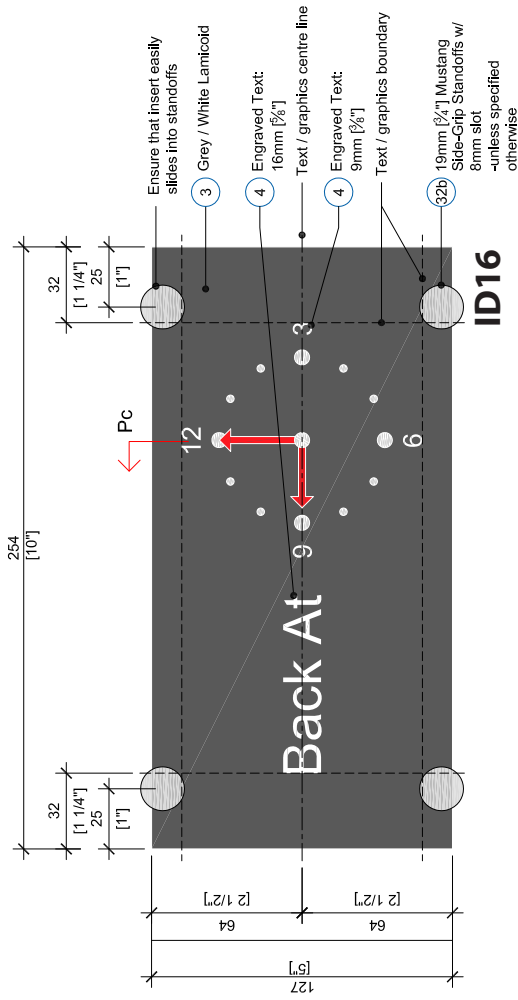

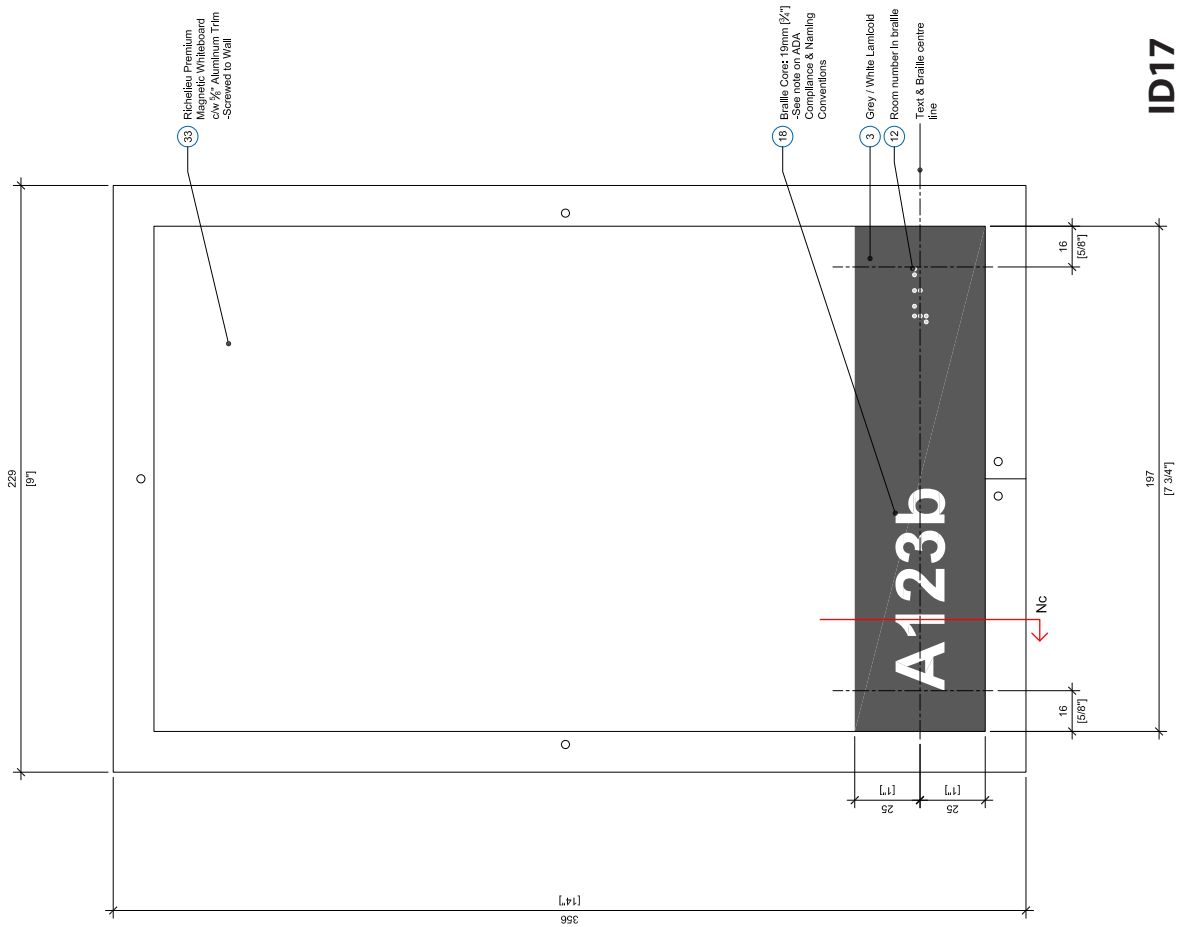

ID17

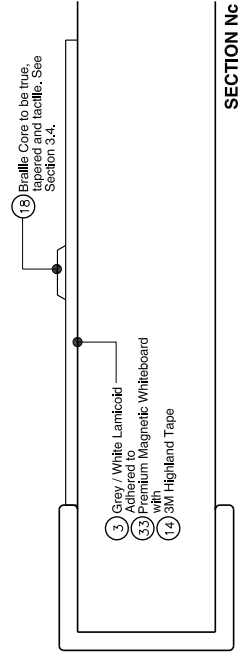

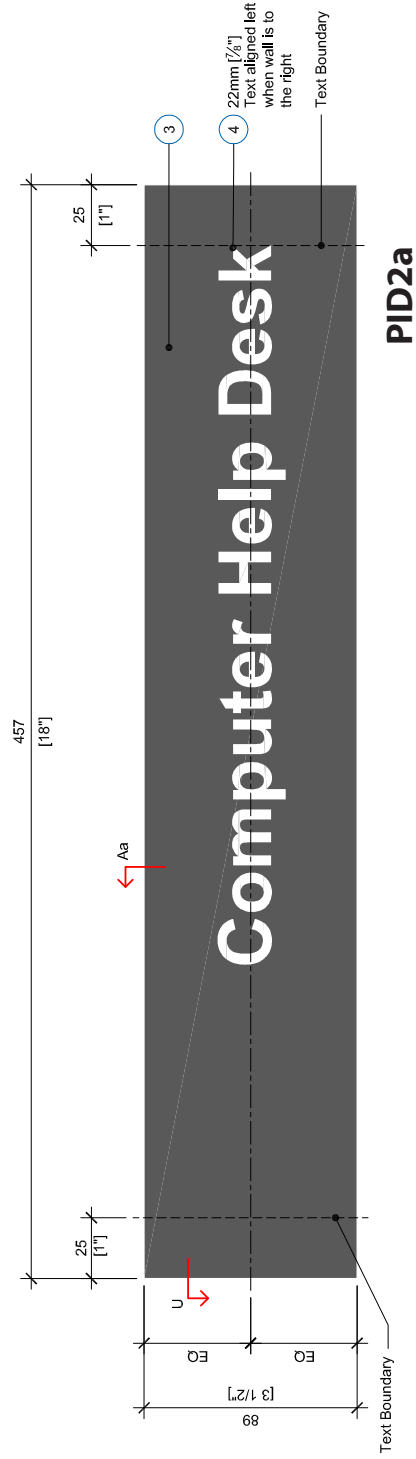
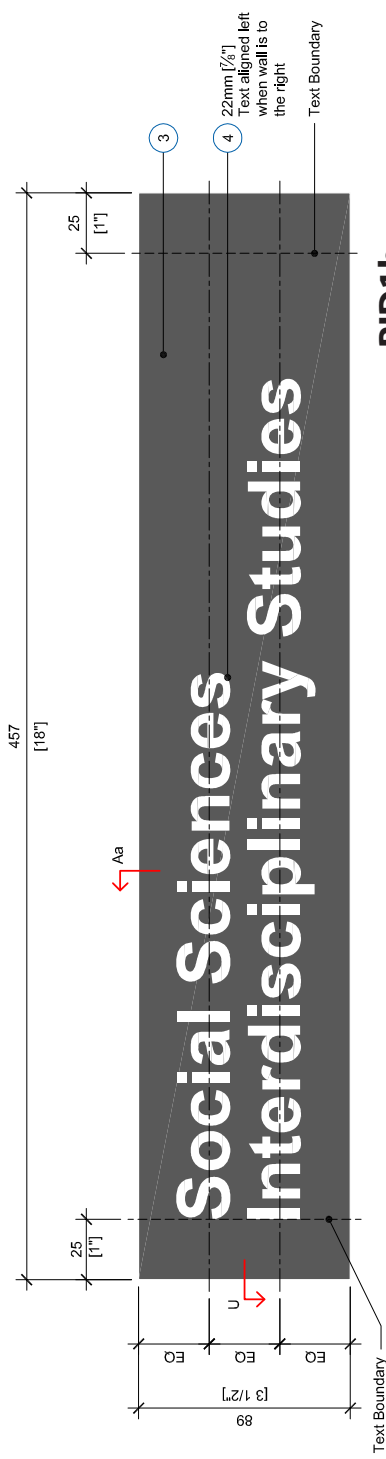
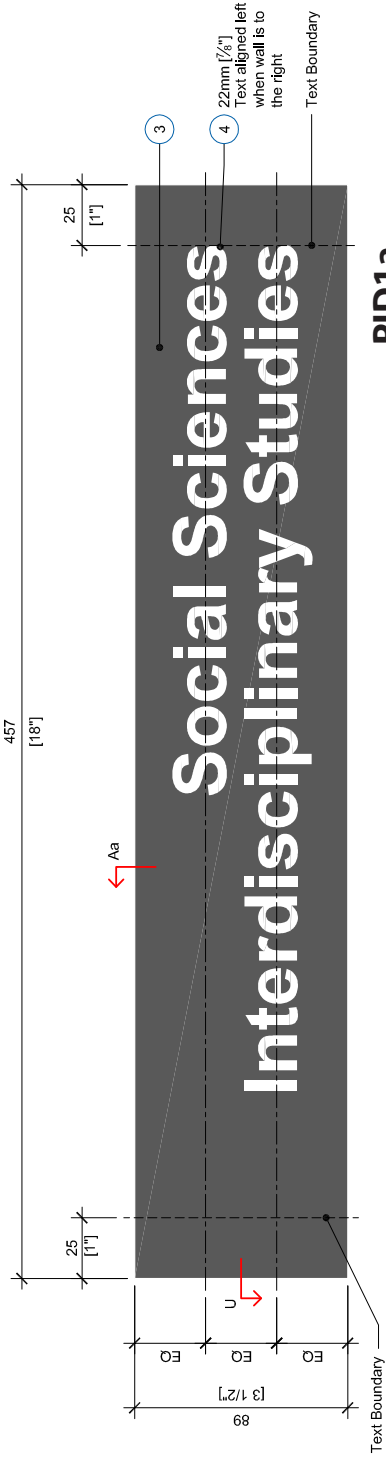

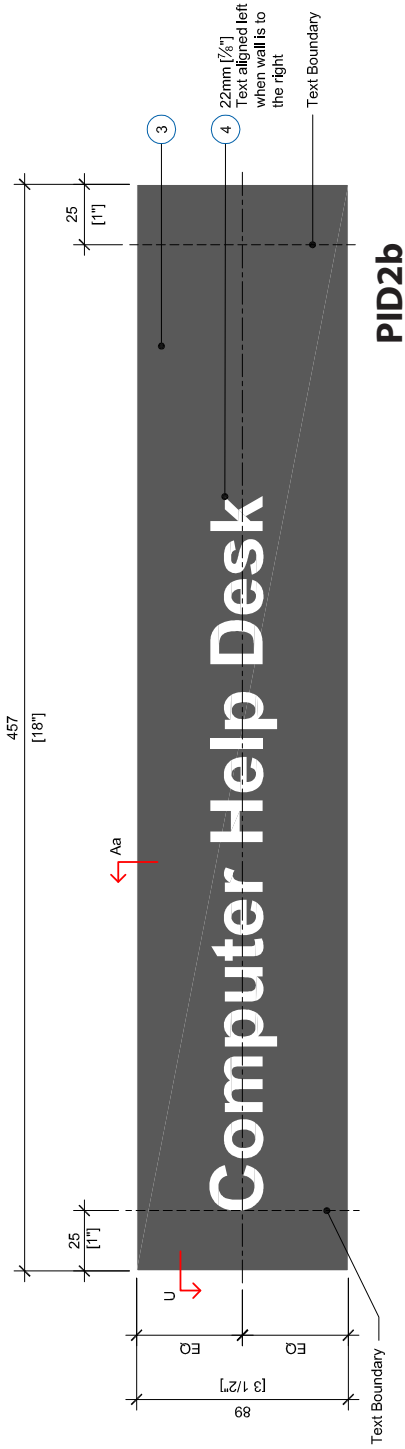

PID2b

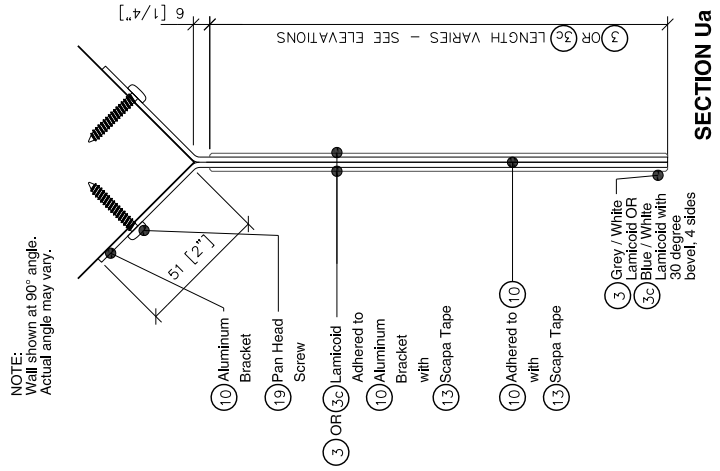

SECTION Ua

Note: Refer to Section Ua when sign is specified to be mounted at angle.

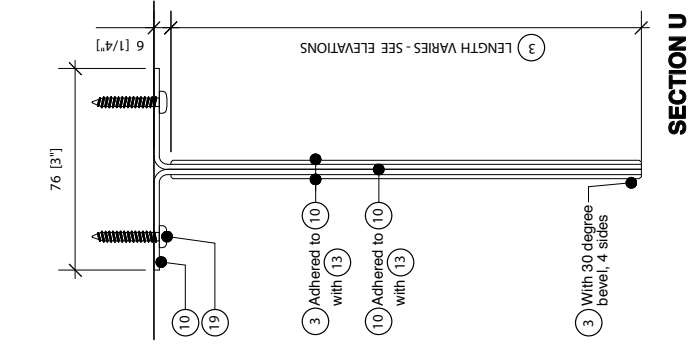

SECTION U

NOTE: See Appendix for typical bevel information

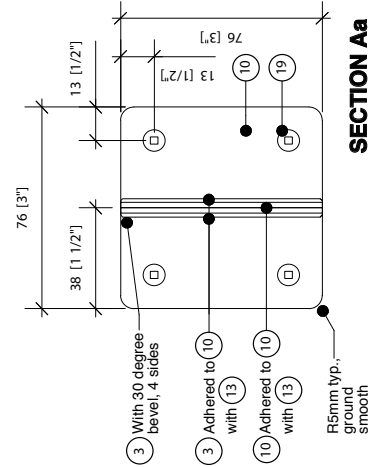

SECTION Aa

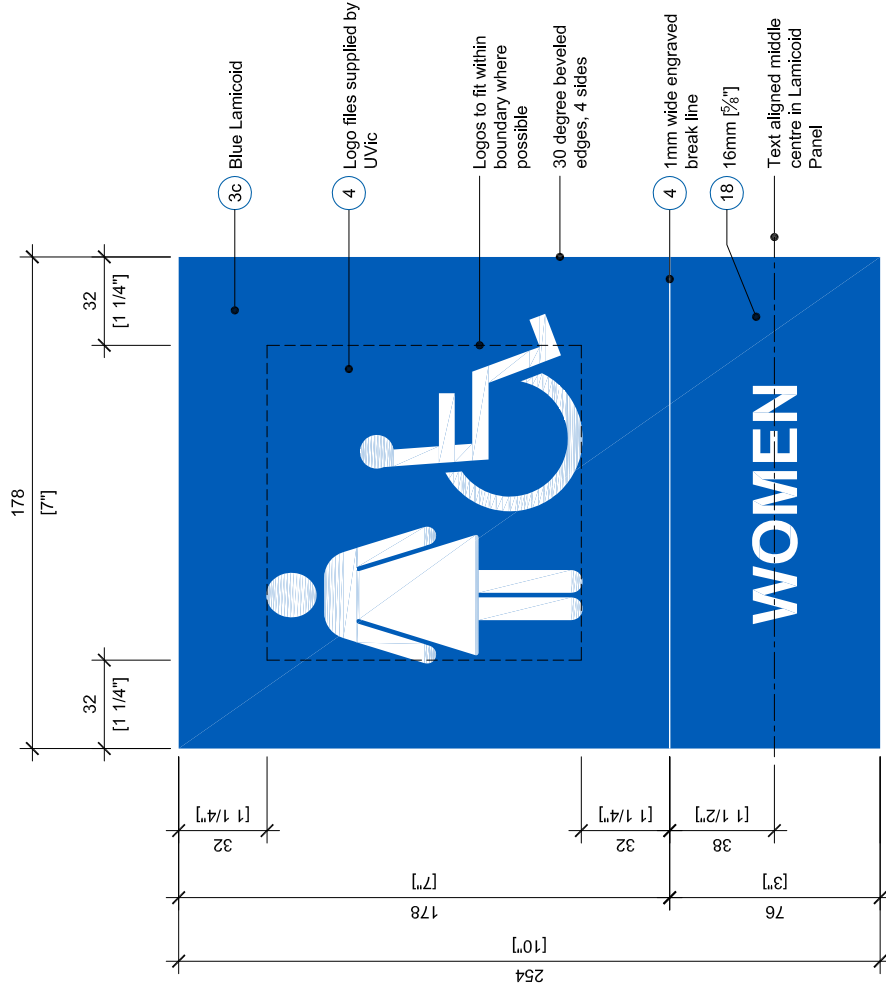

**Note:**

Repeat notes, dimensions and materials from WID1 for sign WID2 and WID29.

Adhere sign to the wall surface using material number (20), double sided tape.

**WID1**

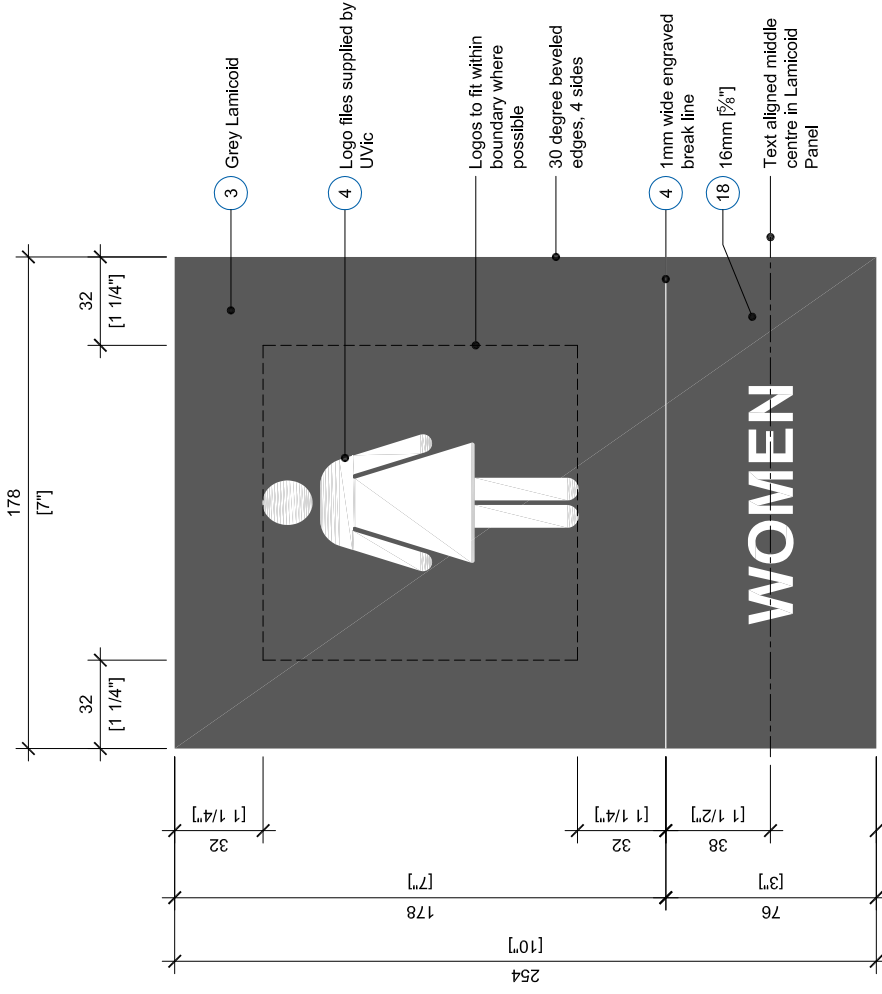

**Note:**

Repeat notes, dimensions and materials from WID4 for signs WID5, WID10, WID11, WID20, WID21, WID22, WID23 and WID30.

Adhere sign to the wall surface using material number (20), double sided tape.

**WID4**

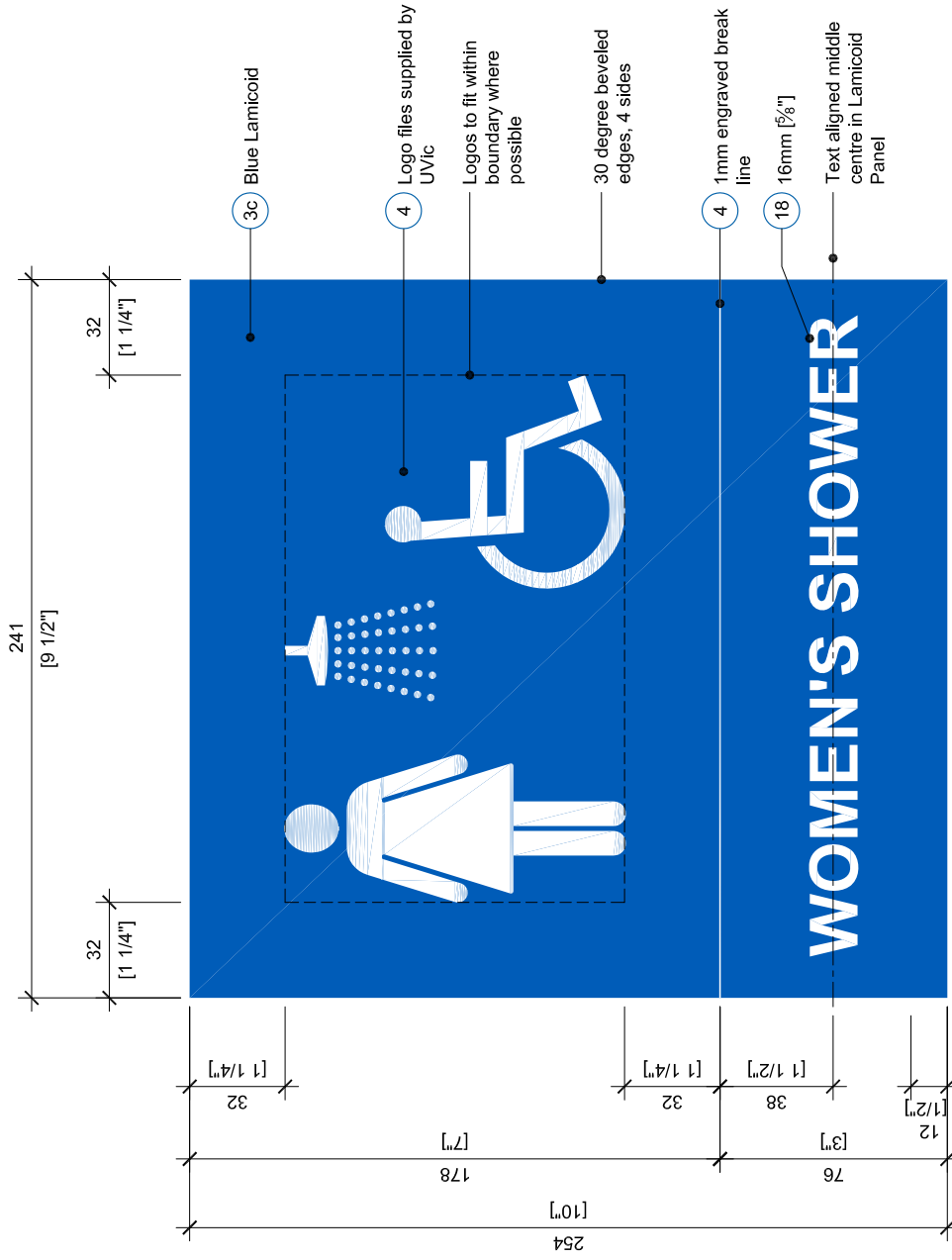

**Note:**

Repeat notes, dimensions and materials from WID3 for signs WID8, WID24 and WID28.

Adhere sign to the wall surface using material number (20), double sided tape.

**WID7**



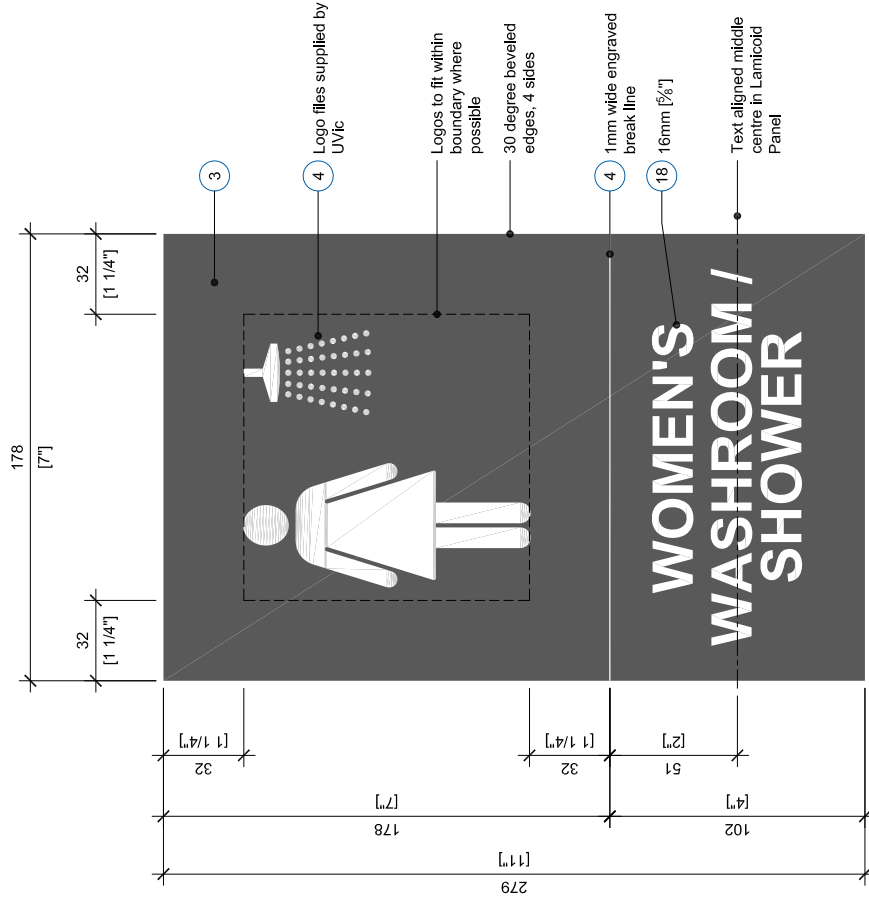

**Note:**

Repeat notes, dimensions and materials from WID13 for sign WID14.

Adhere sign to the wall surface using material number (20), double sided tape.

**WID13**

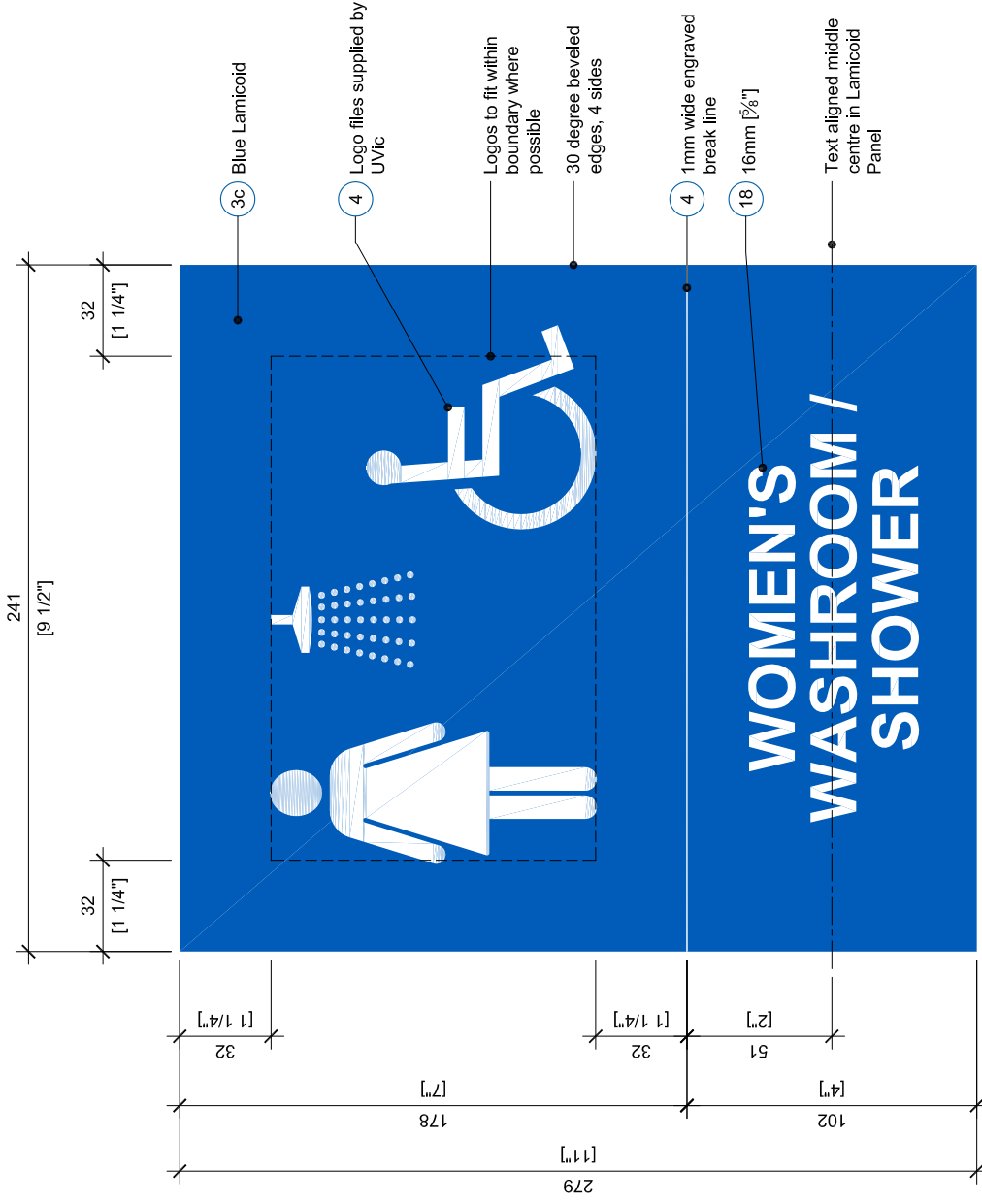

**WID15**

**Note:**

Repeat notes, dimensions and materials from WID15 for sign WID16.

Adhere sign to the wall surface using material number (20), double sided tape.

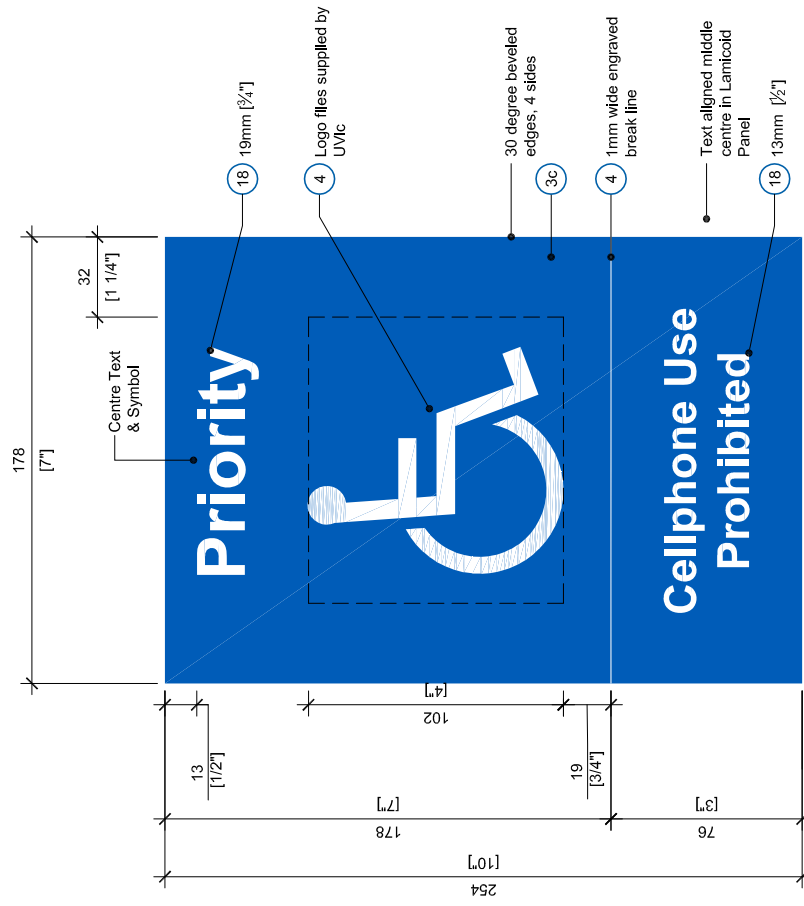

**Note:**

Adhere sign to the door surface using material number (20), 3/4" double sided foam tape.

**WID17**



# WASHROOM IDENTIFICATION [WID DETAILS]

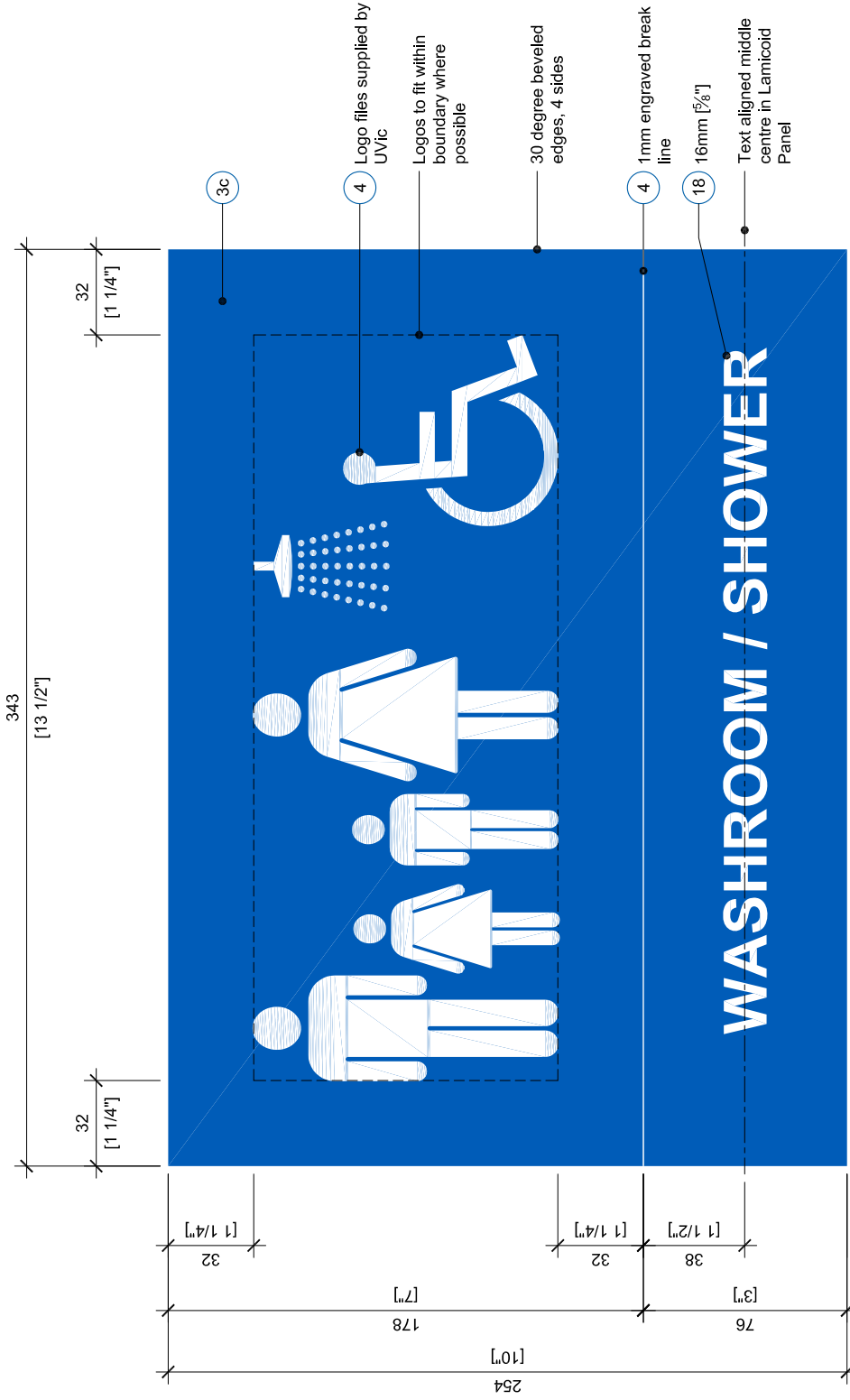

**Note:**  
Adhere sign to the wall surface using material number (20), double sided tape.

**WID18**

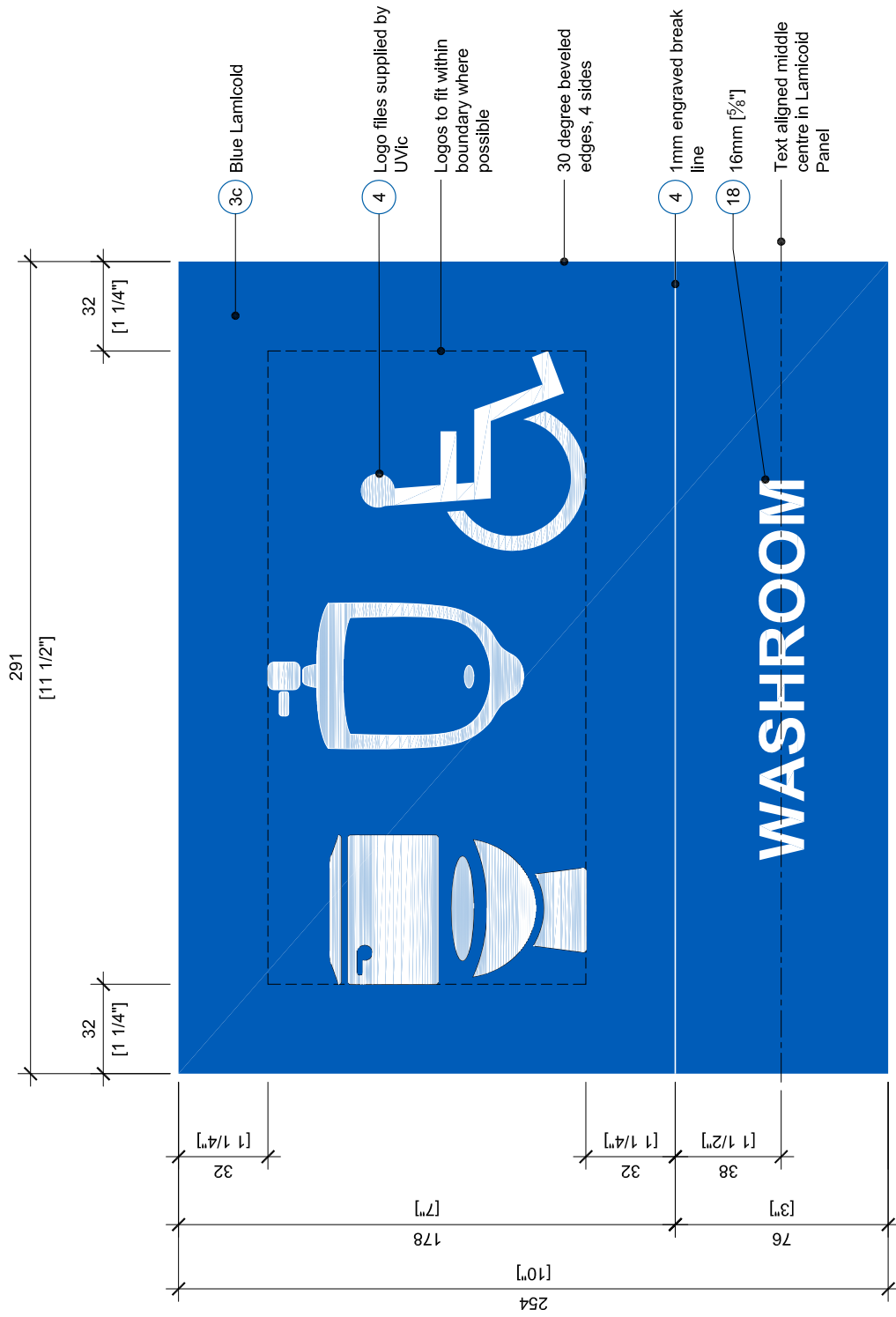

WID26

**Note:**  
Adhere sign to the wall surface using material number (20), double sided tape.

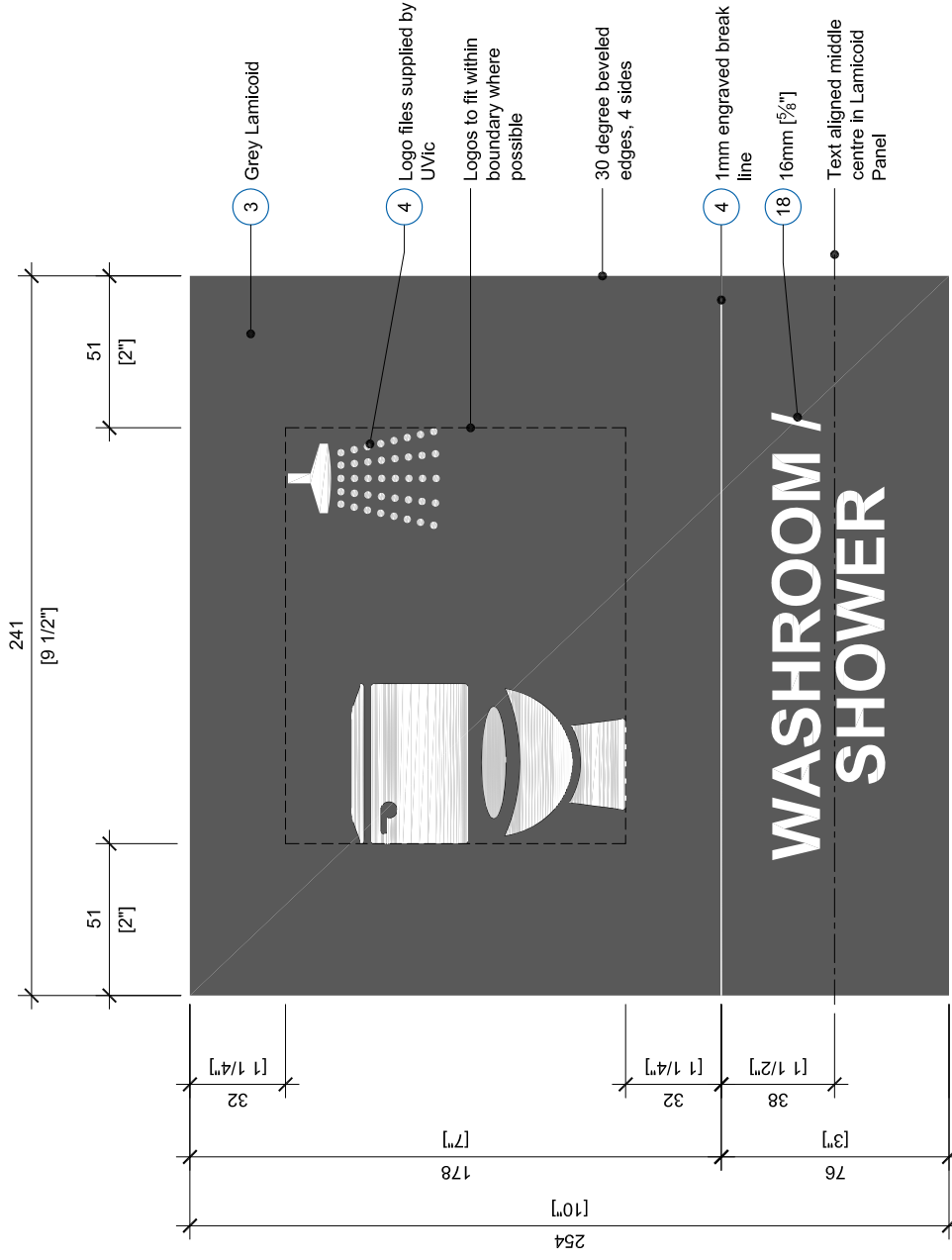

WID27

**Note:** Repeat notes, dimensions and materials from WID27 for sign WID25.

Adhere sign to the wall surface using material number (20), double sided tape.

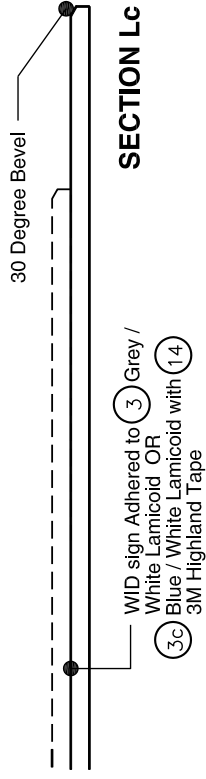
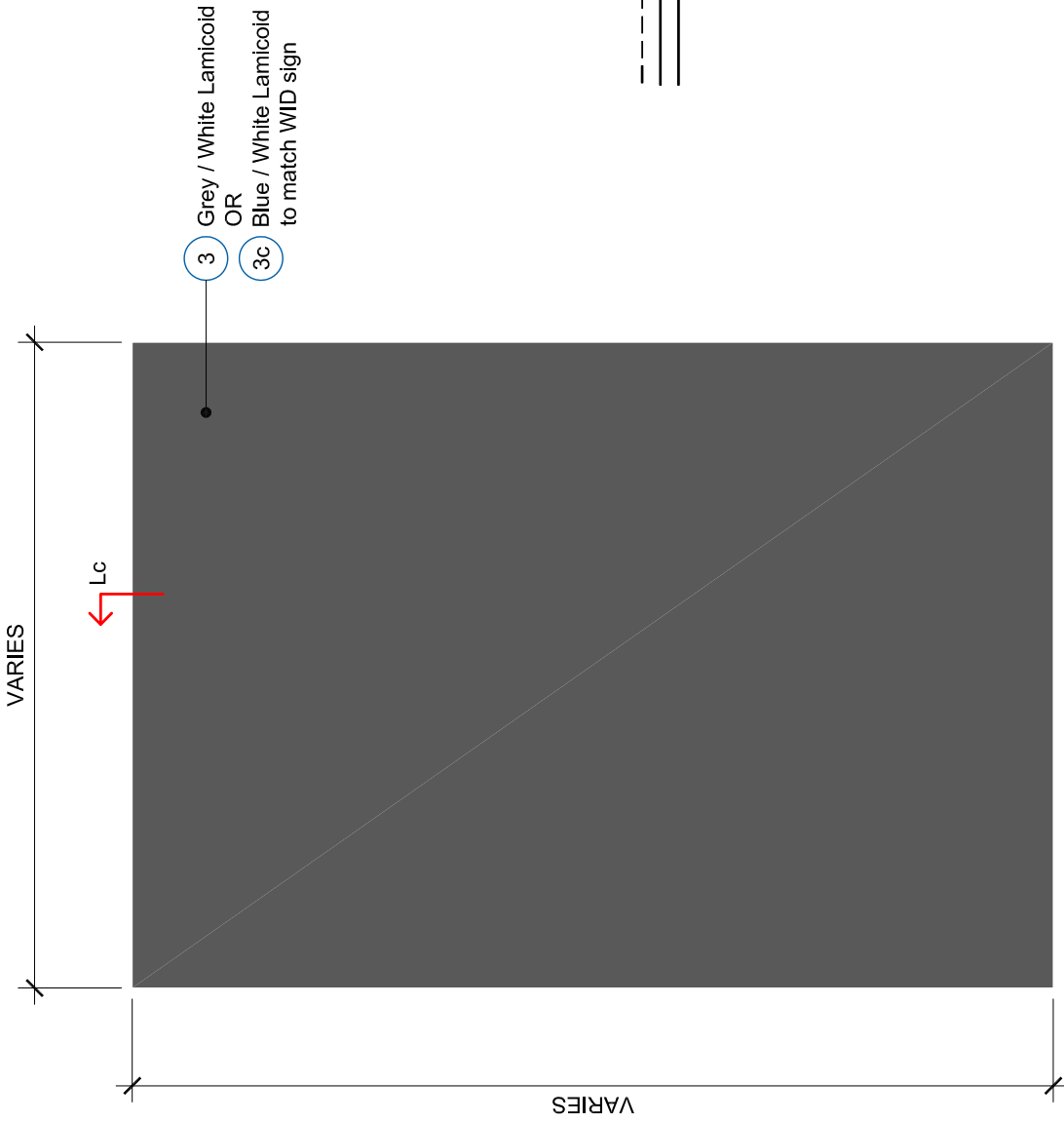

**Note:**

Adhere sign to the wall surface using material number (20), double sided tape.

**WB**

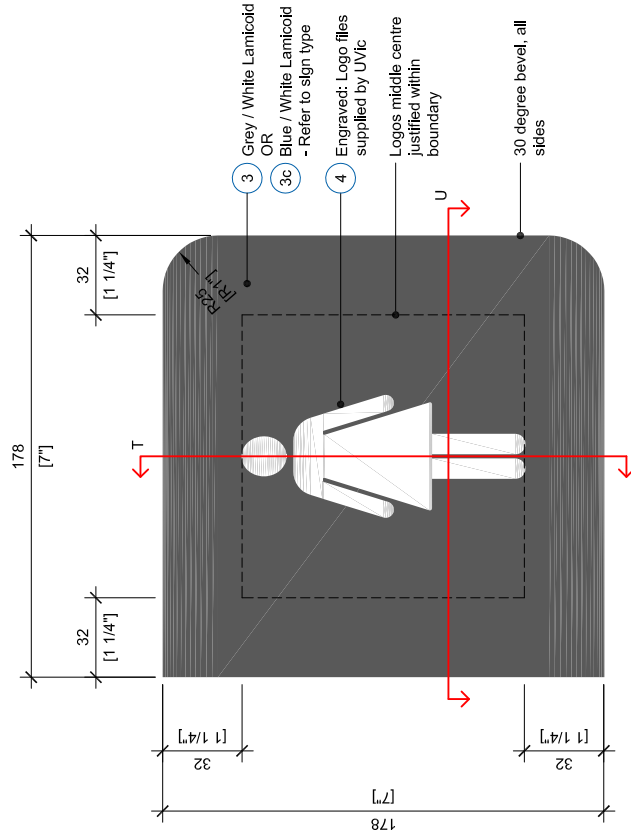

**Note:**

Repeat notes, dimensions and materials from WP4 for signs WP1, WP2, WP4a, WP5, WP5a, WP14, WP20 and WP21.

**WP4**

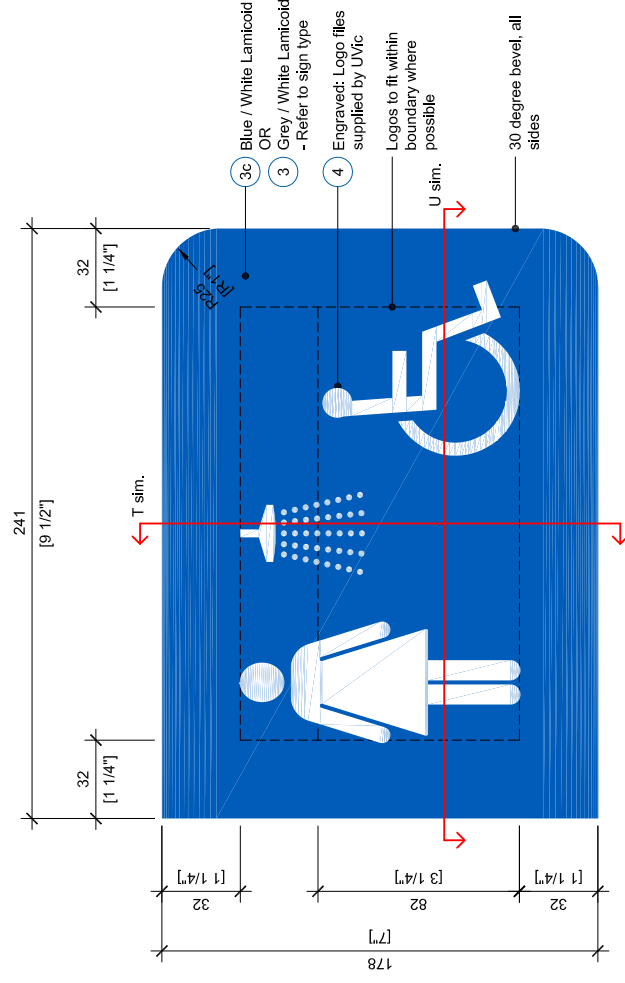

**Note:**

Repeat notes, dimensions and materials from WP7 for signs WP8, WP15, WP16, WP18, WP19 and WP19.

**WP7**



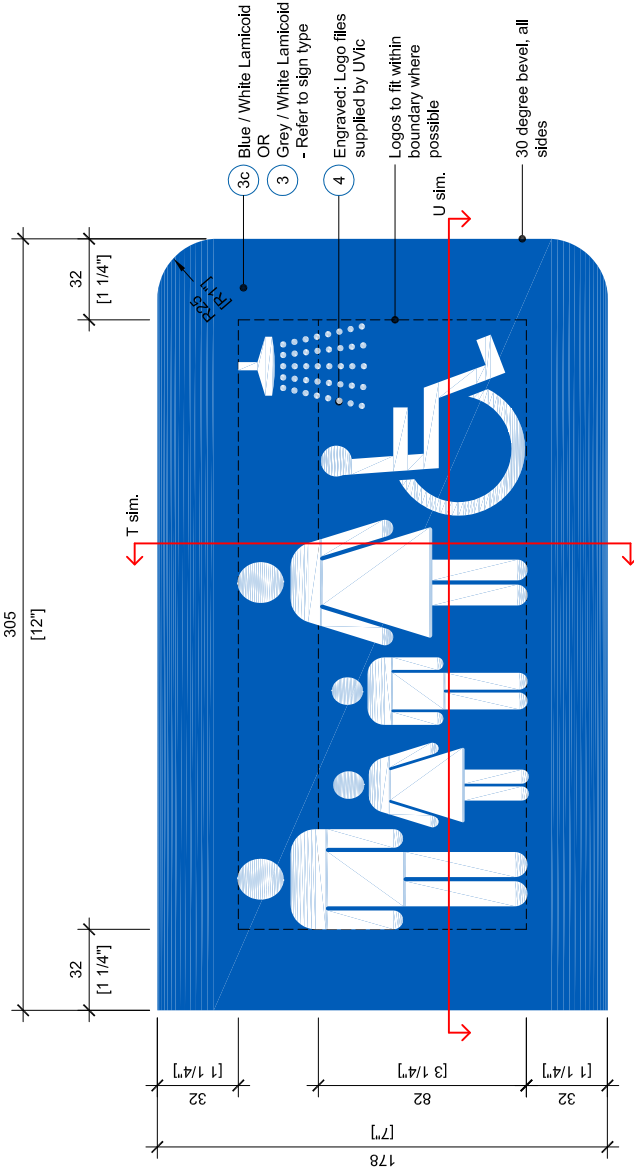

**Note:**

Repeat notes, dimensions and materials from WP11 for sign WP17.

**WP11**

NOTE: See WP17 for typical bevel information.

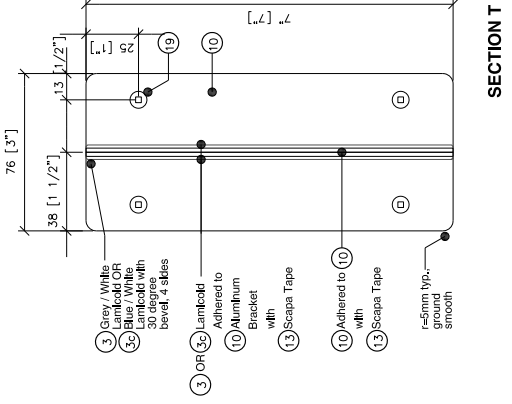

SECTION T

NOTE: Wall shown at 90° angle. Actual angle may vary.

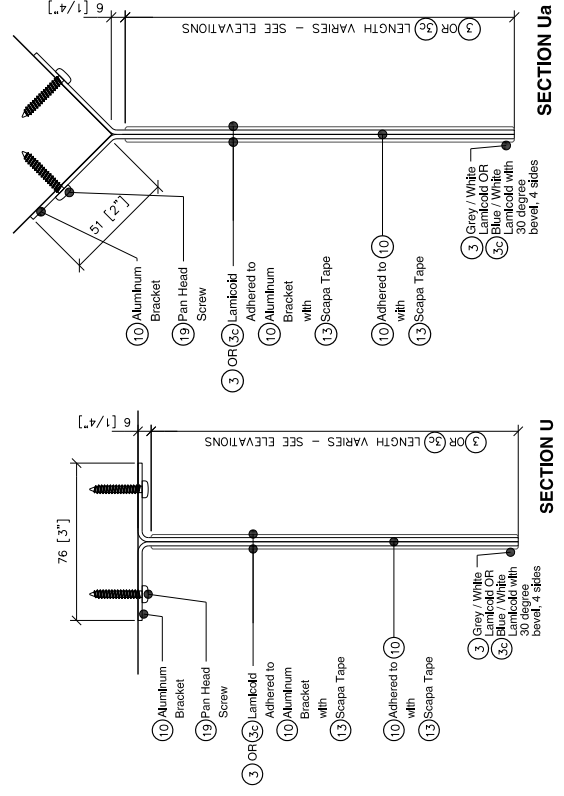

SECTION U

SECTION Ua

Note: Refer to Section Ua when sign is specified to be mounted at angle.

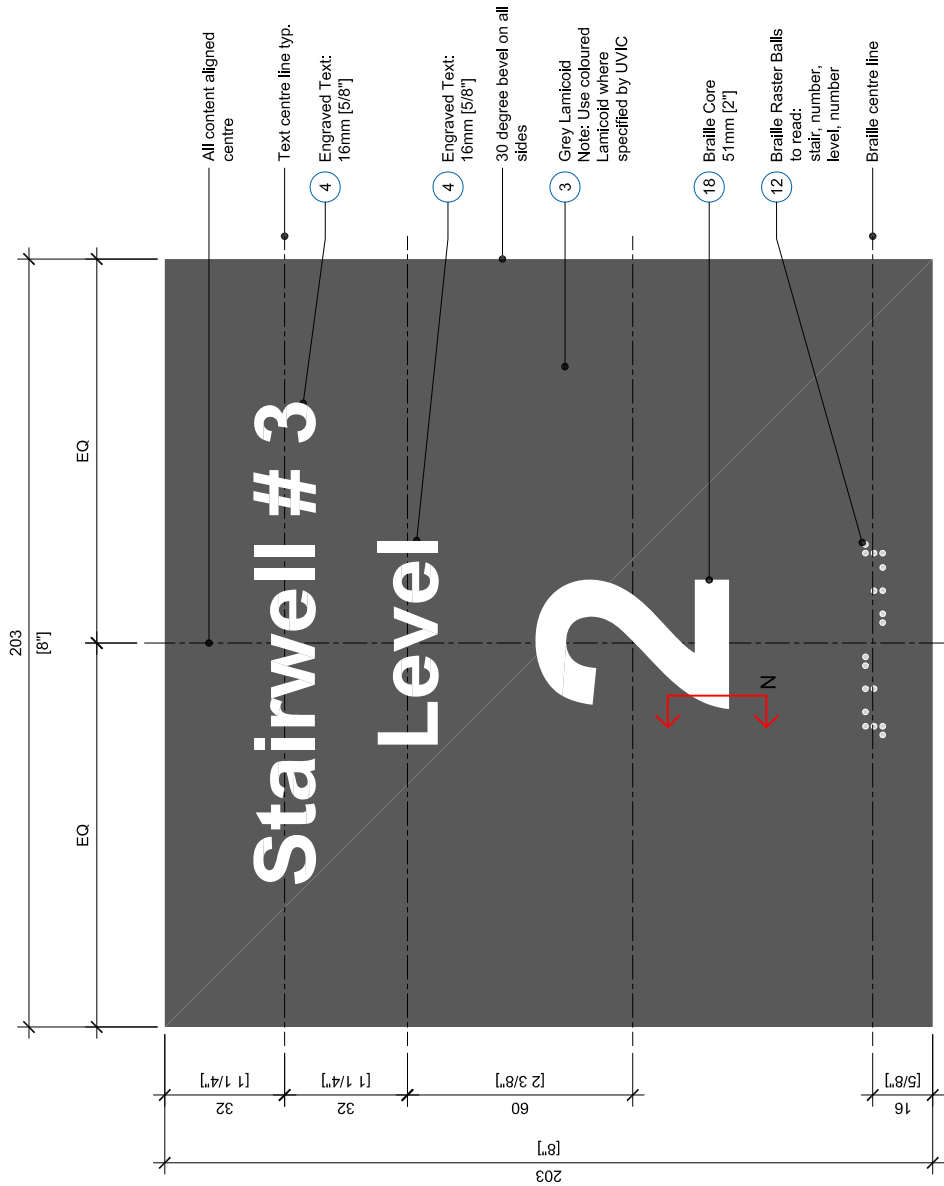

S1

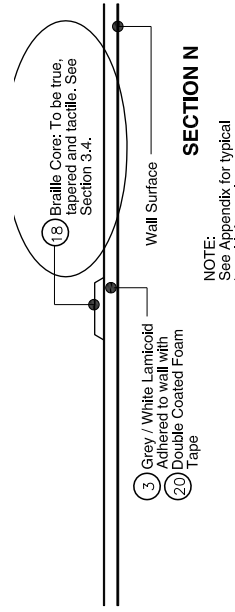

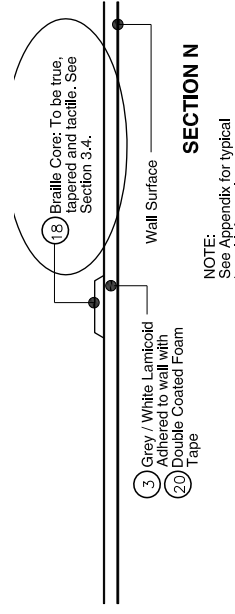
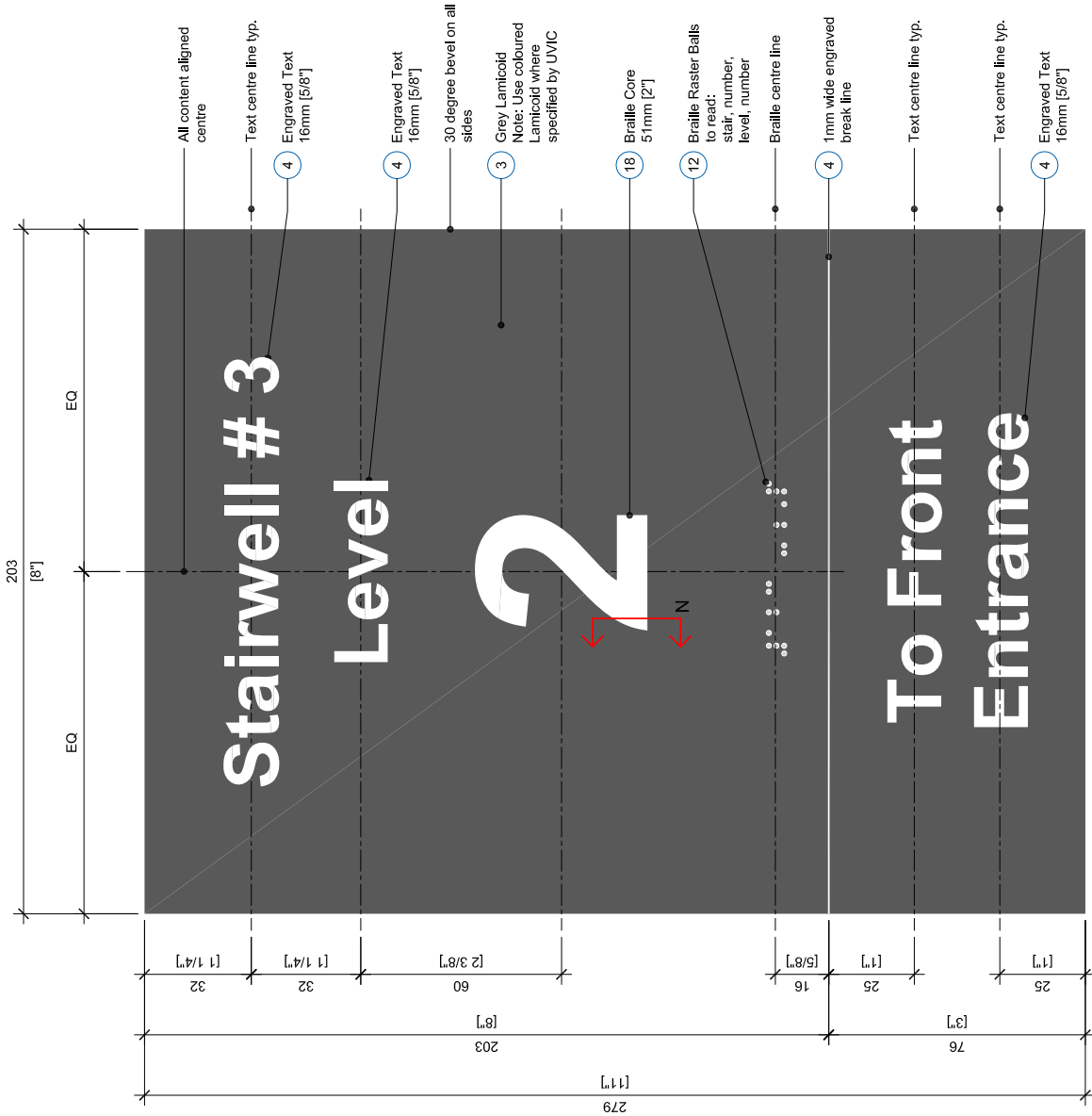

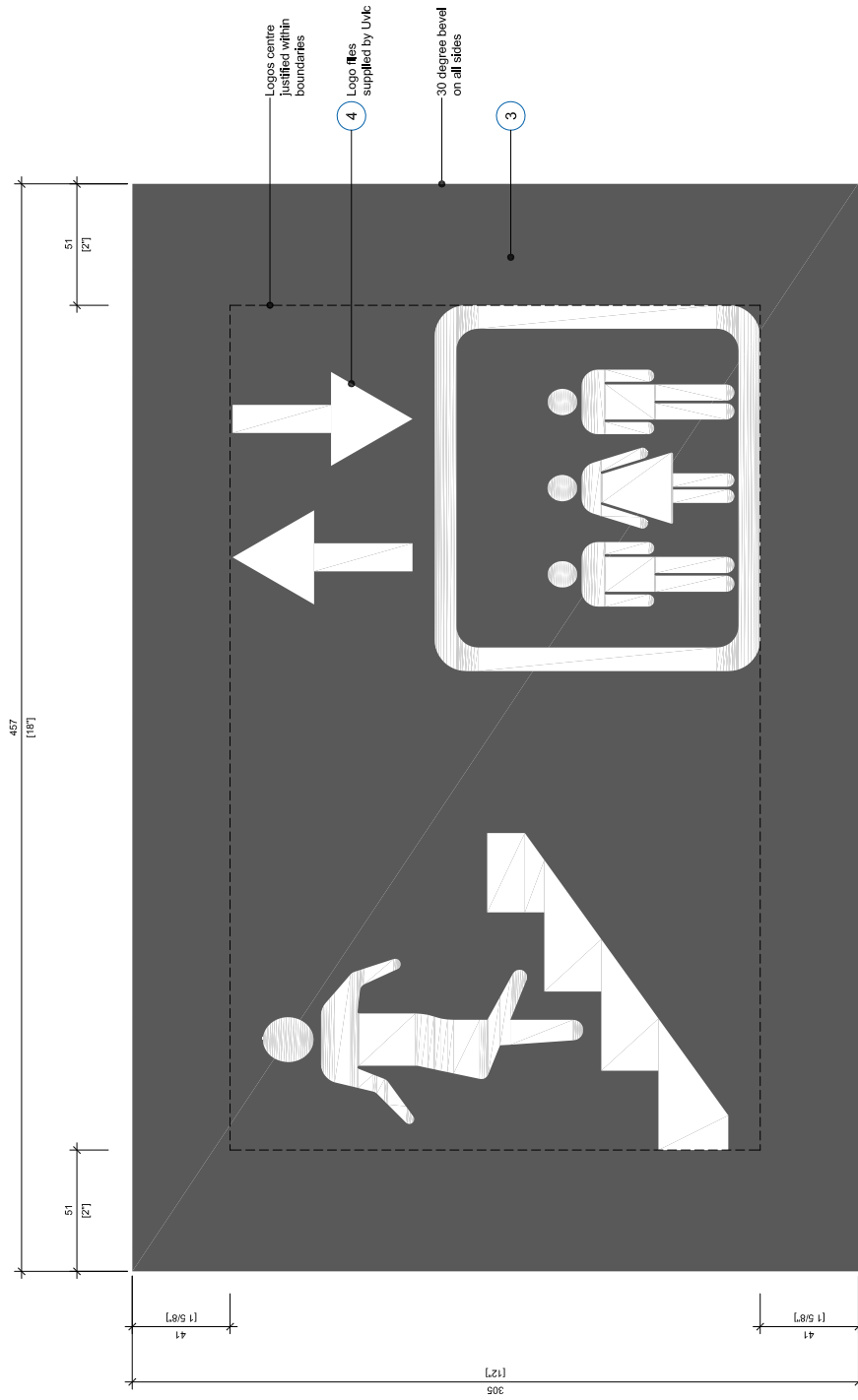

S3

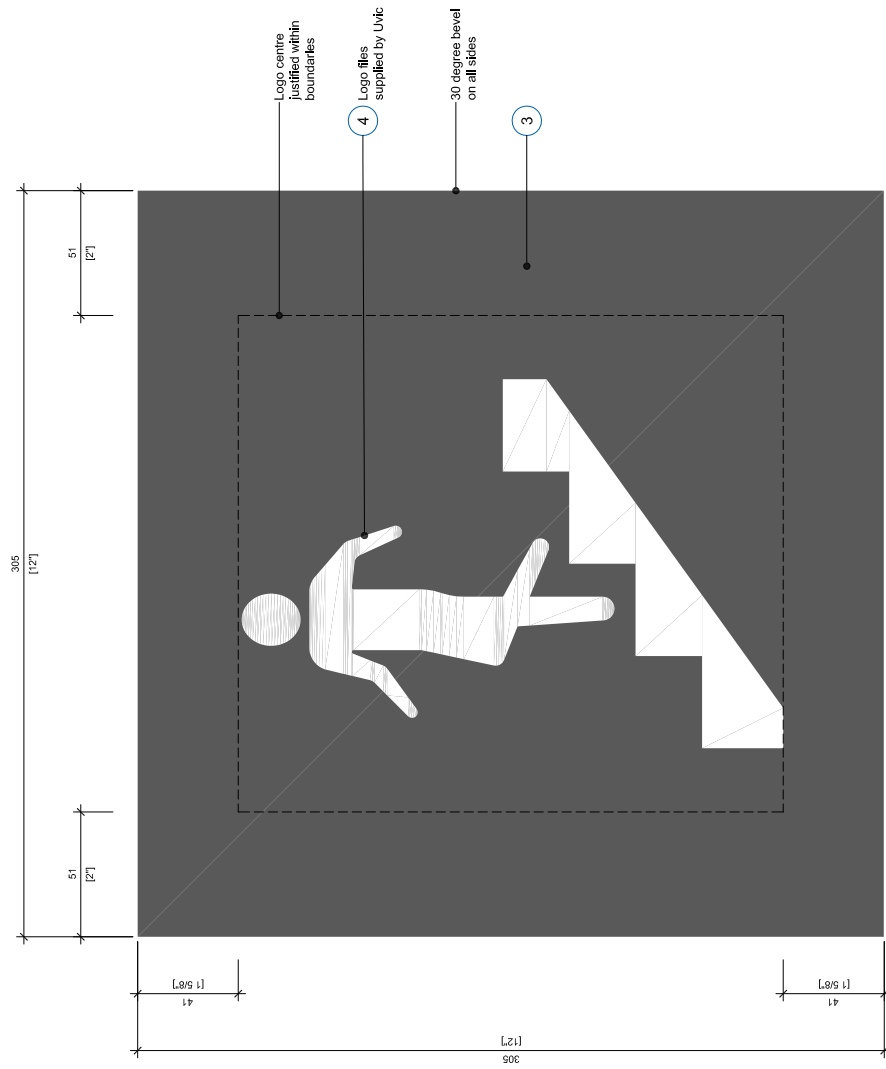

S4

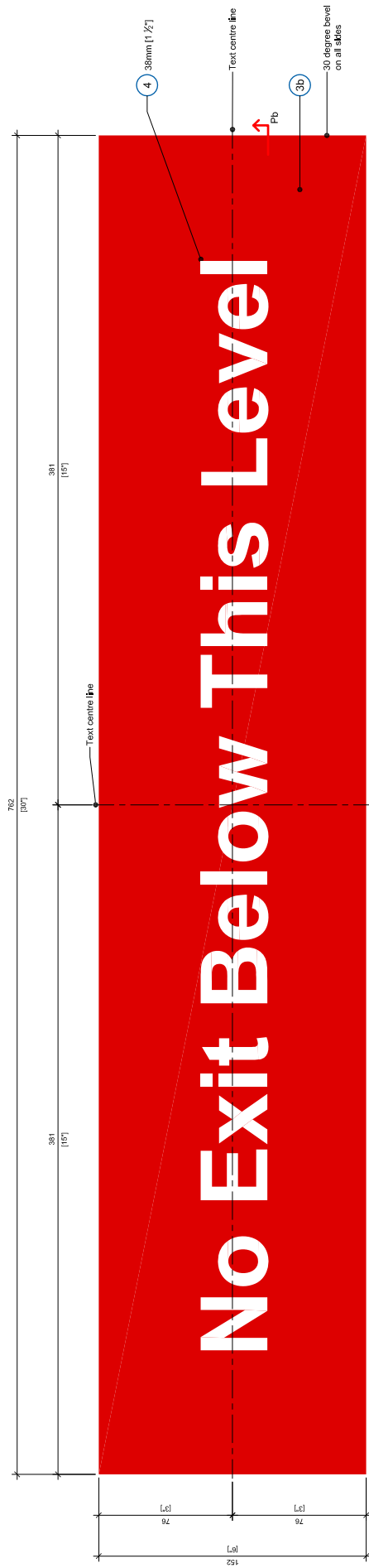

S5

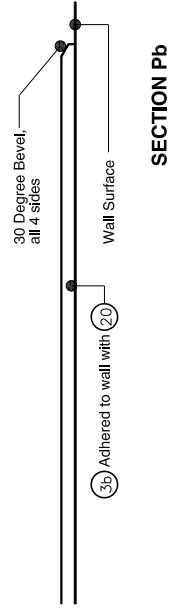

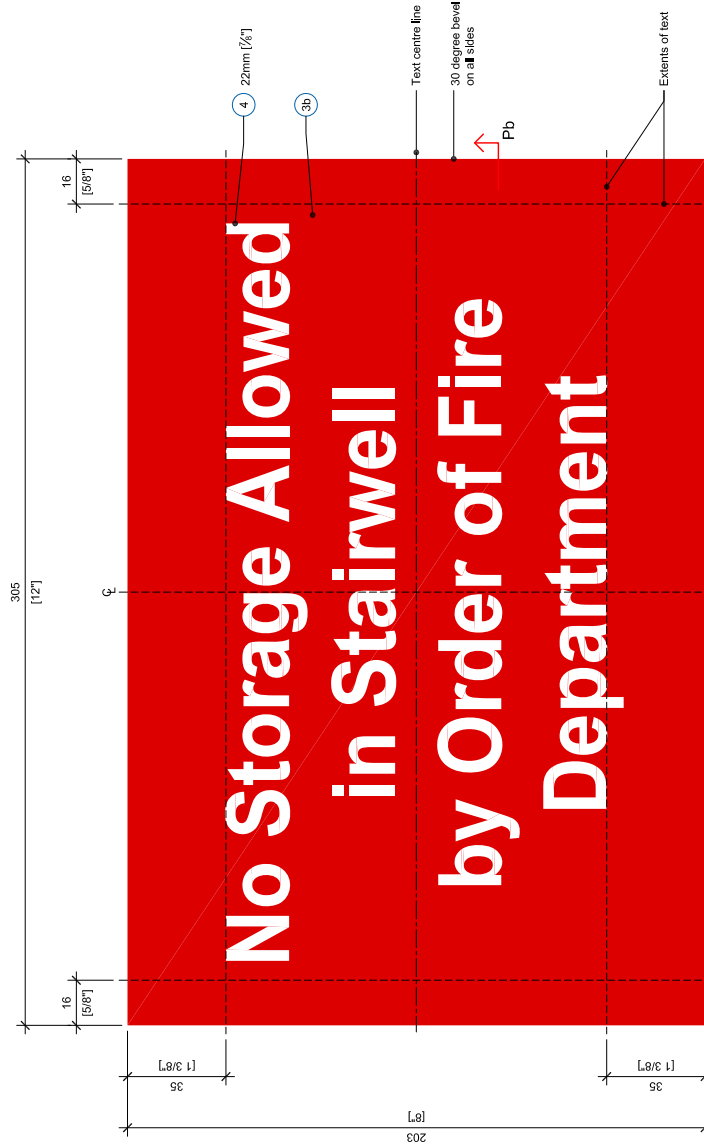

S6

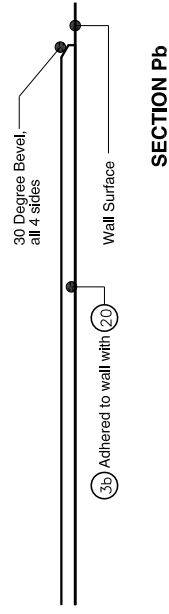

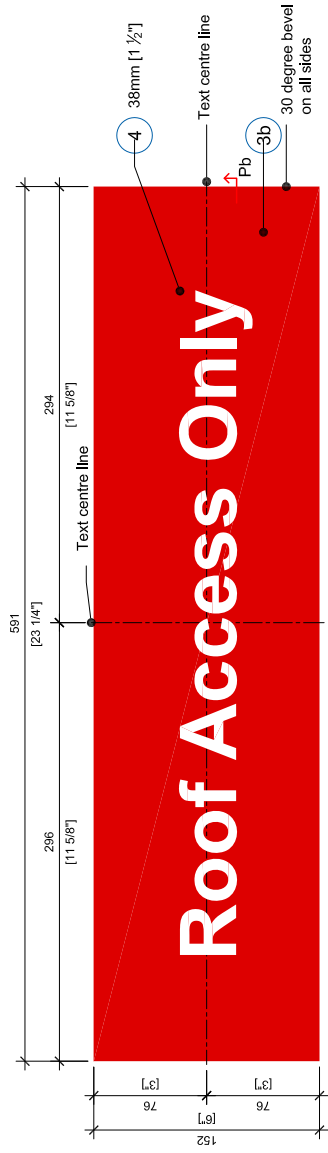

S7

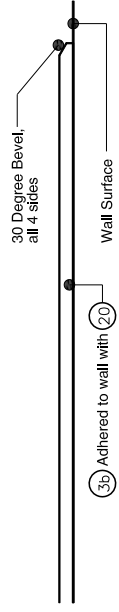

SECTION Pb



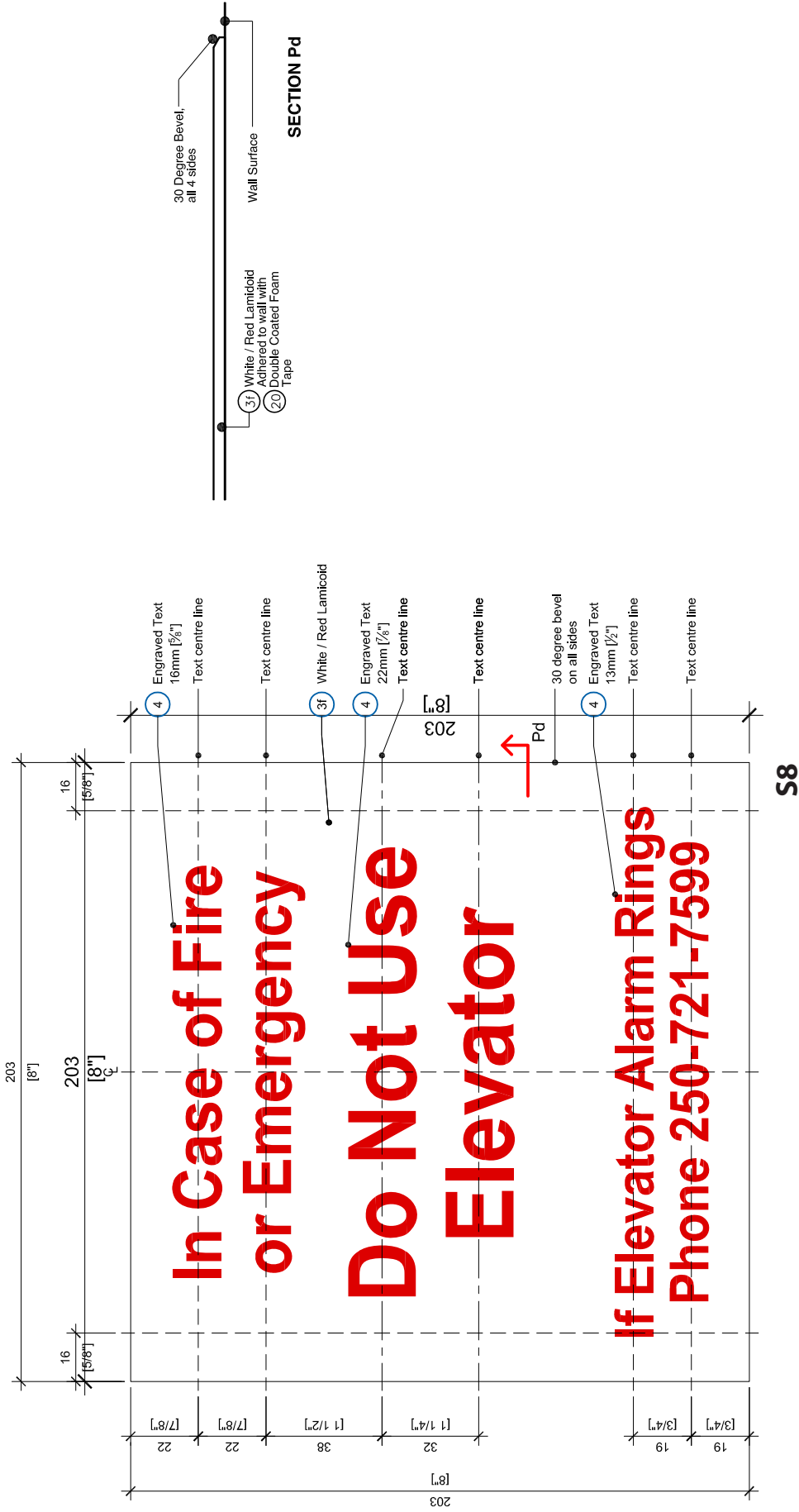



NOTE: See Appendix for typical bevel information

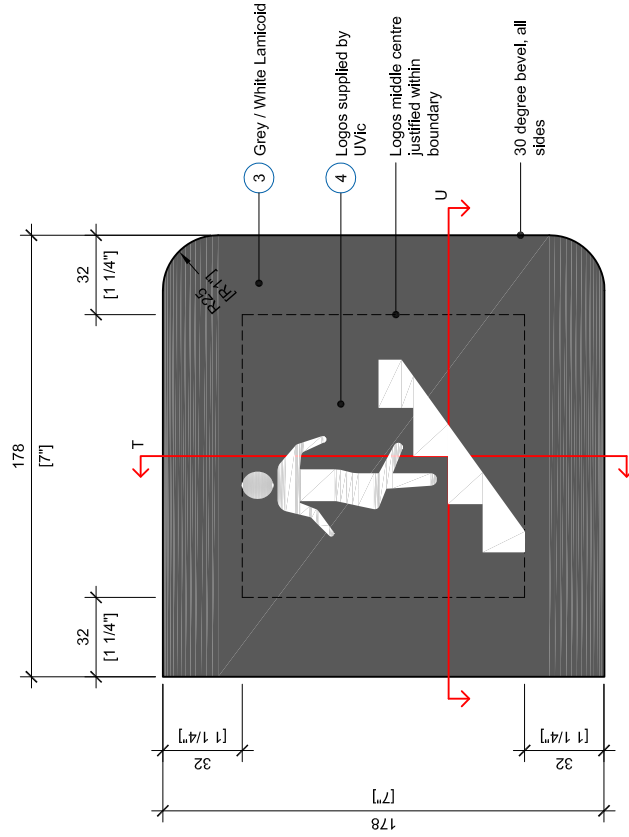
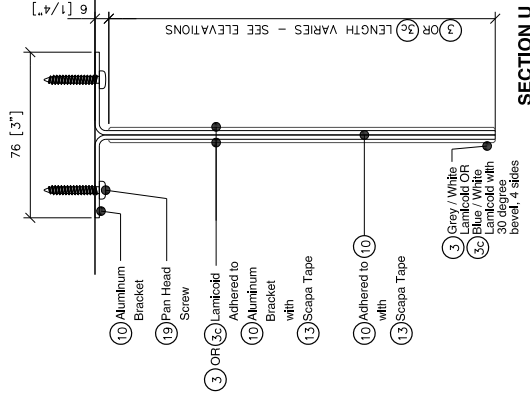
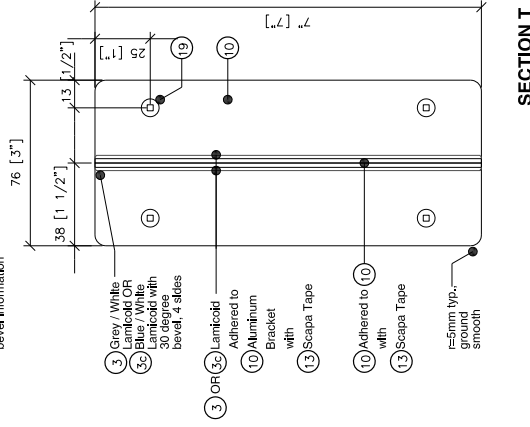

NOTE: Wall shown at 90° angle. Actual angle may vary.

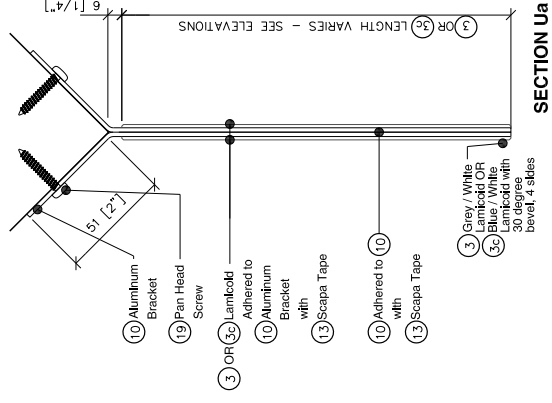

Note: Refer to Section Ua when sign is specified to be mounted at angle.

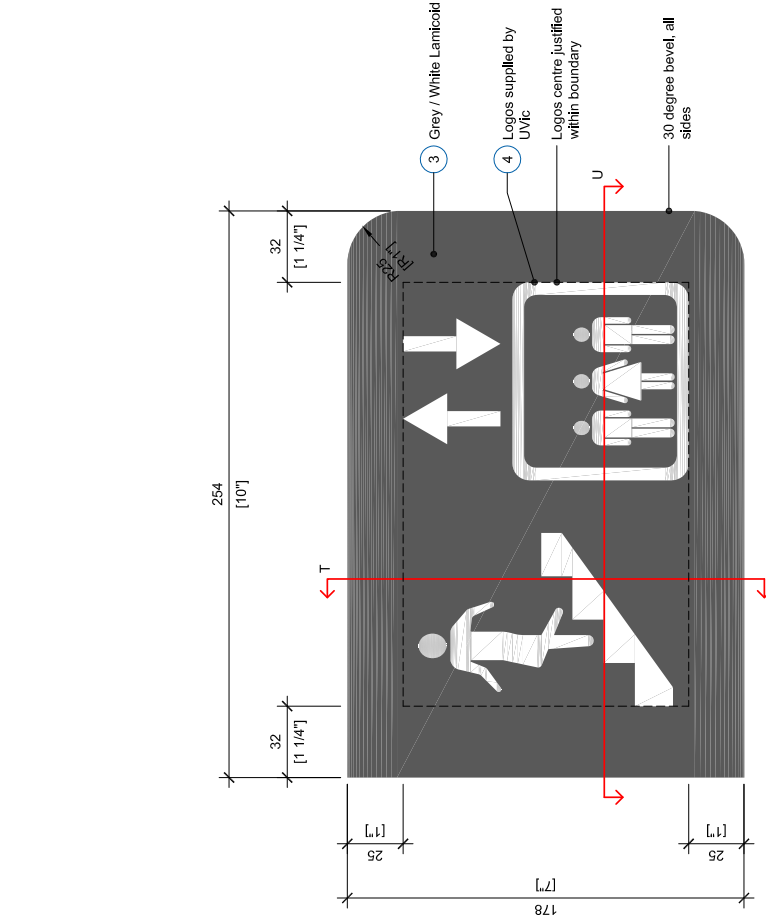

P3

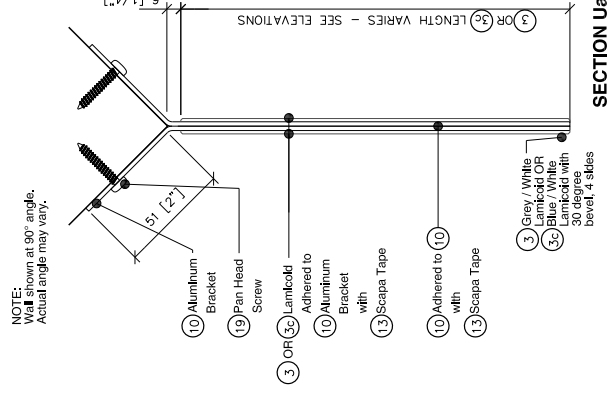
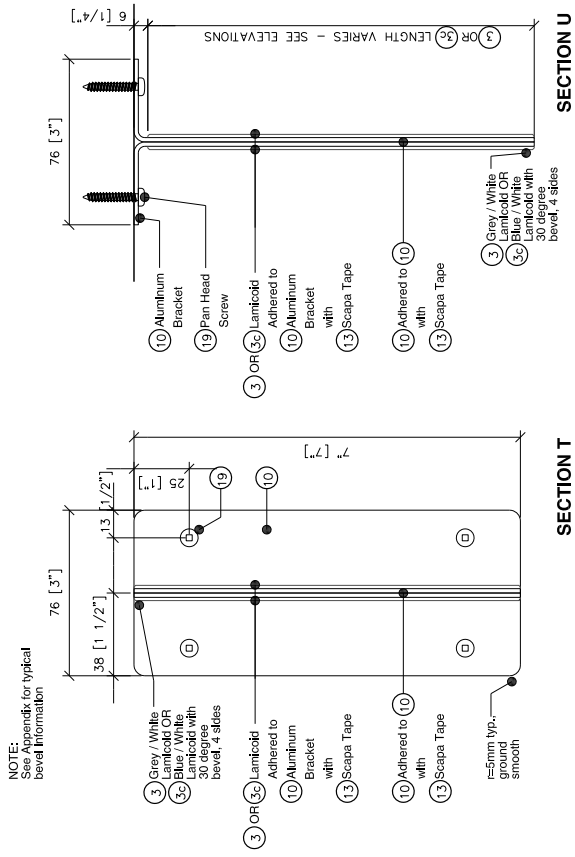

Note: Refer to Section Ua when sign is specified to be mounted at angle.



NOTE:  
See Appendix for typical  
bevel information

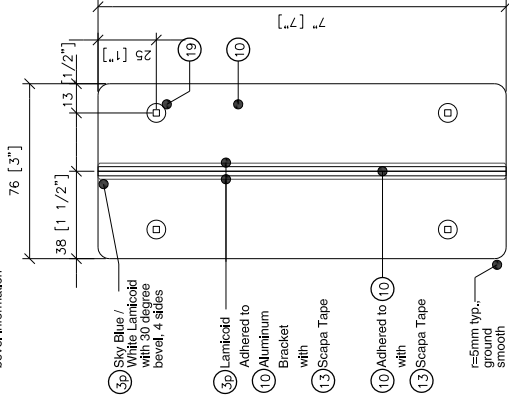

SECTION Tb

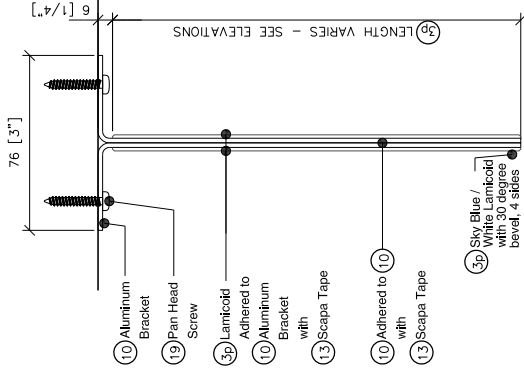

SECTION Ub

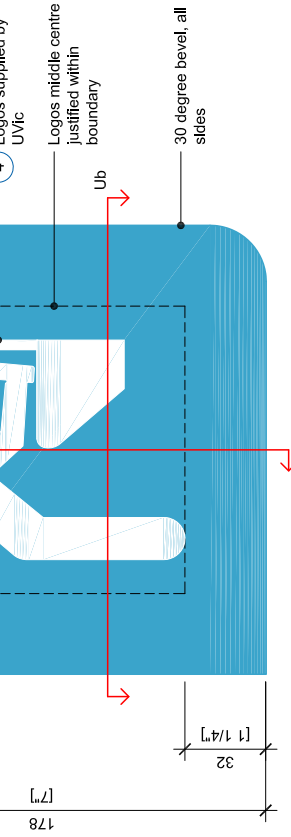

P4

NOTE:  
Wall shown at 90° angle.  
Actual angle may vary.

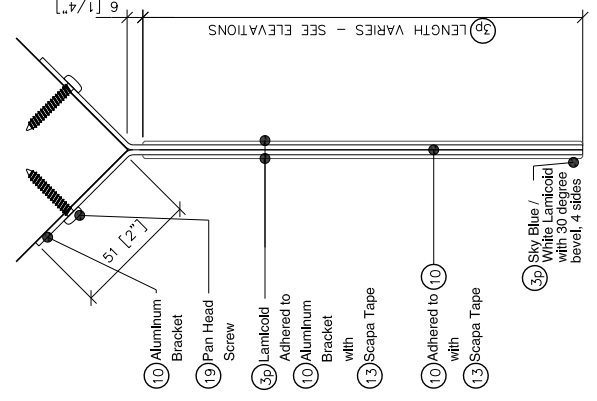

Note: Refer to Section Uc when sign is  
specified to be mounted at angle.

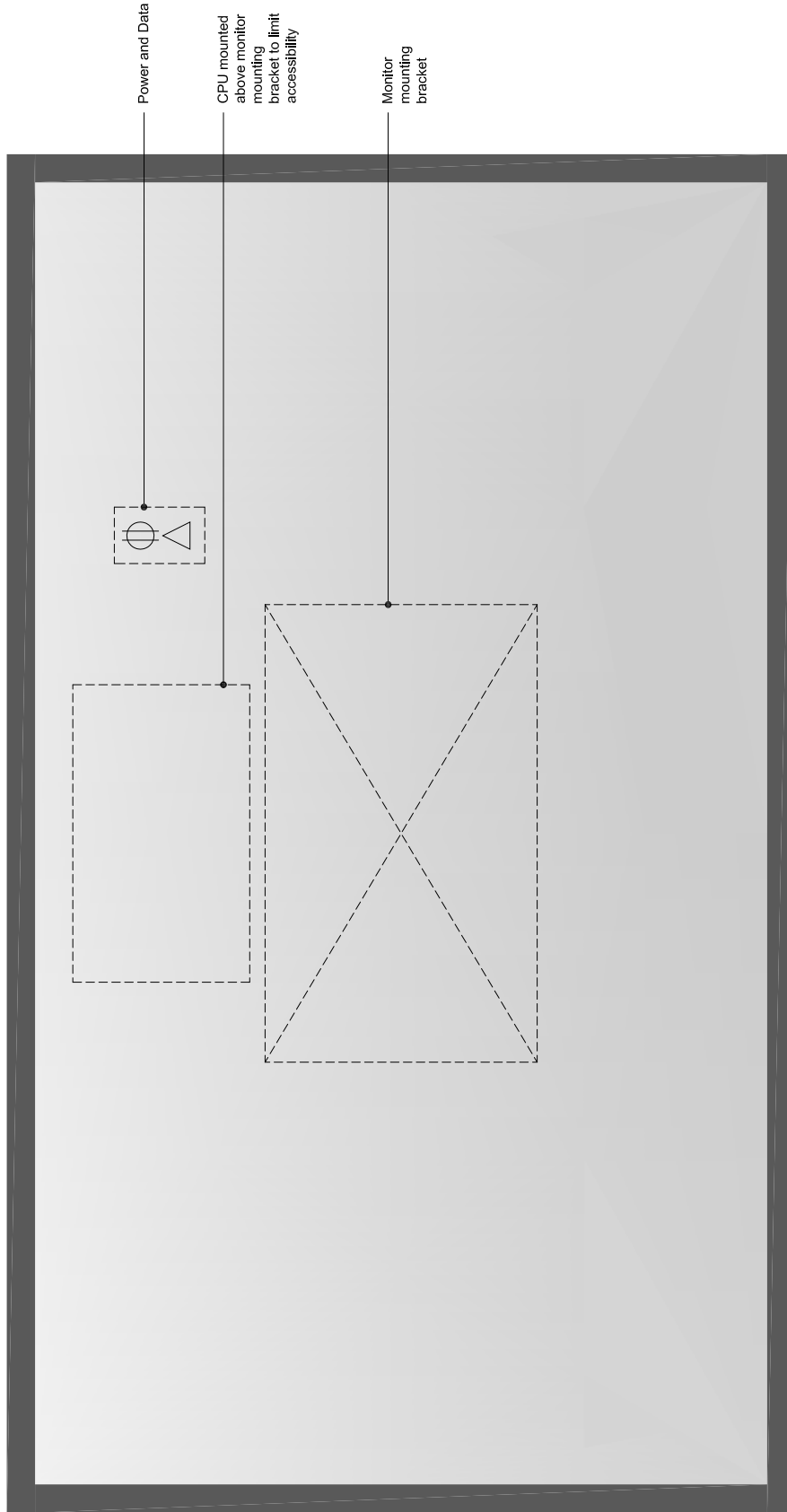

**M1**



**Colors:**

Grey: Pantone 425C



Red: Pantone 185C



Yellow: Pantone 109C



Green: Pantone 341C



Black: Process Black

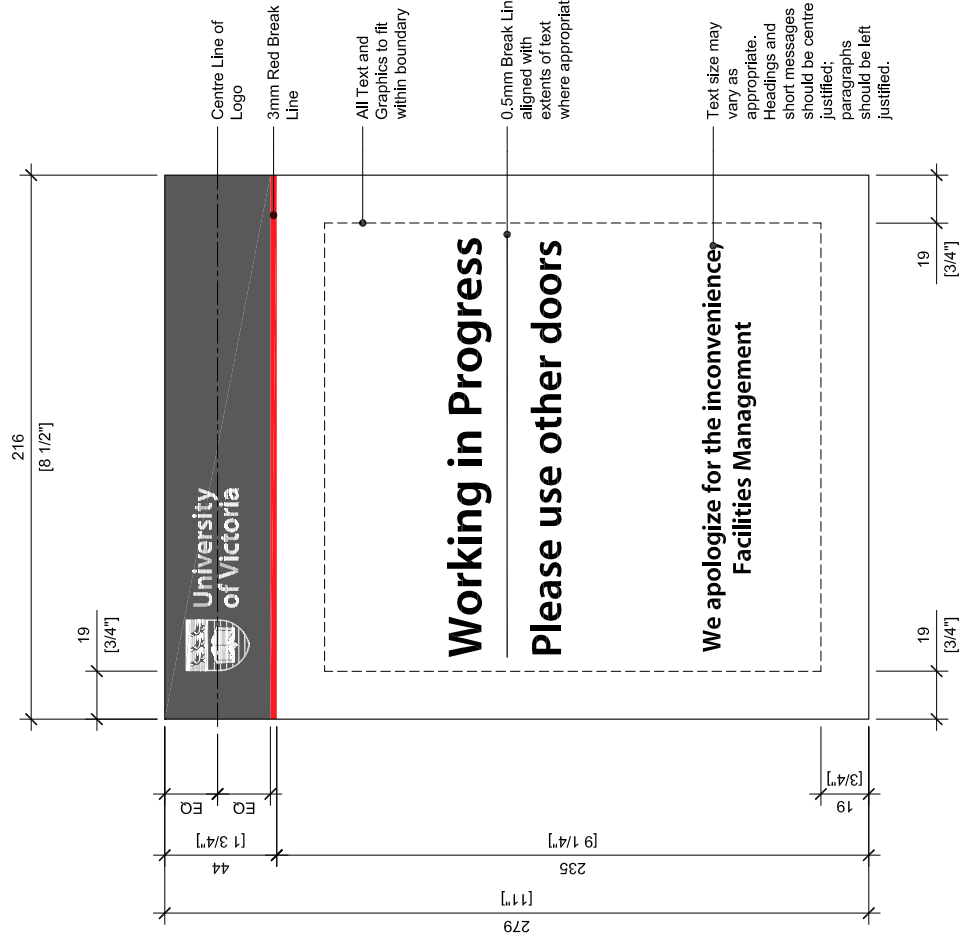

N2

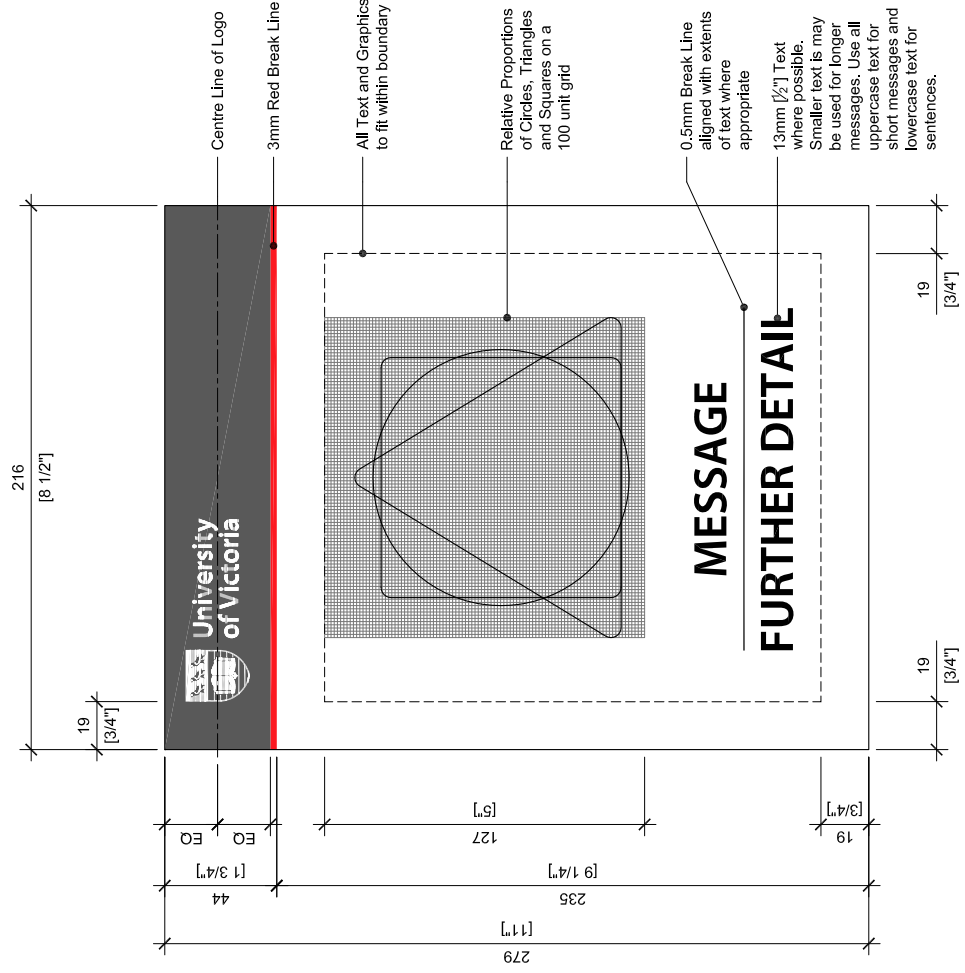

N1

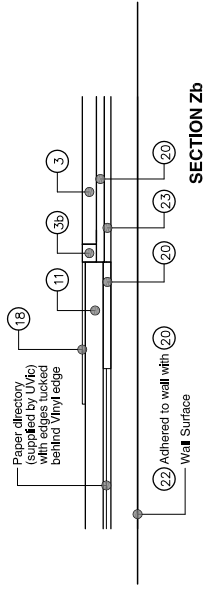
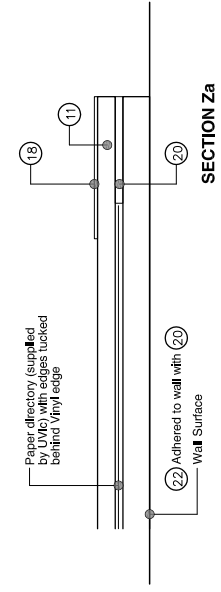
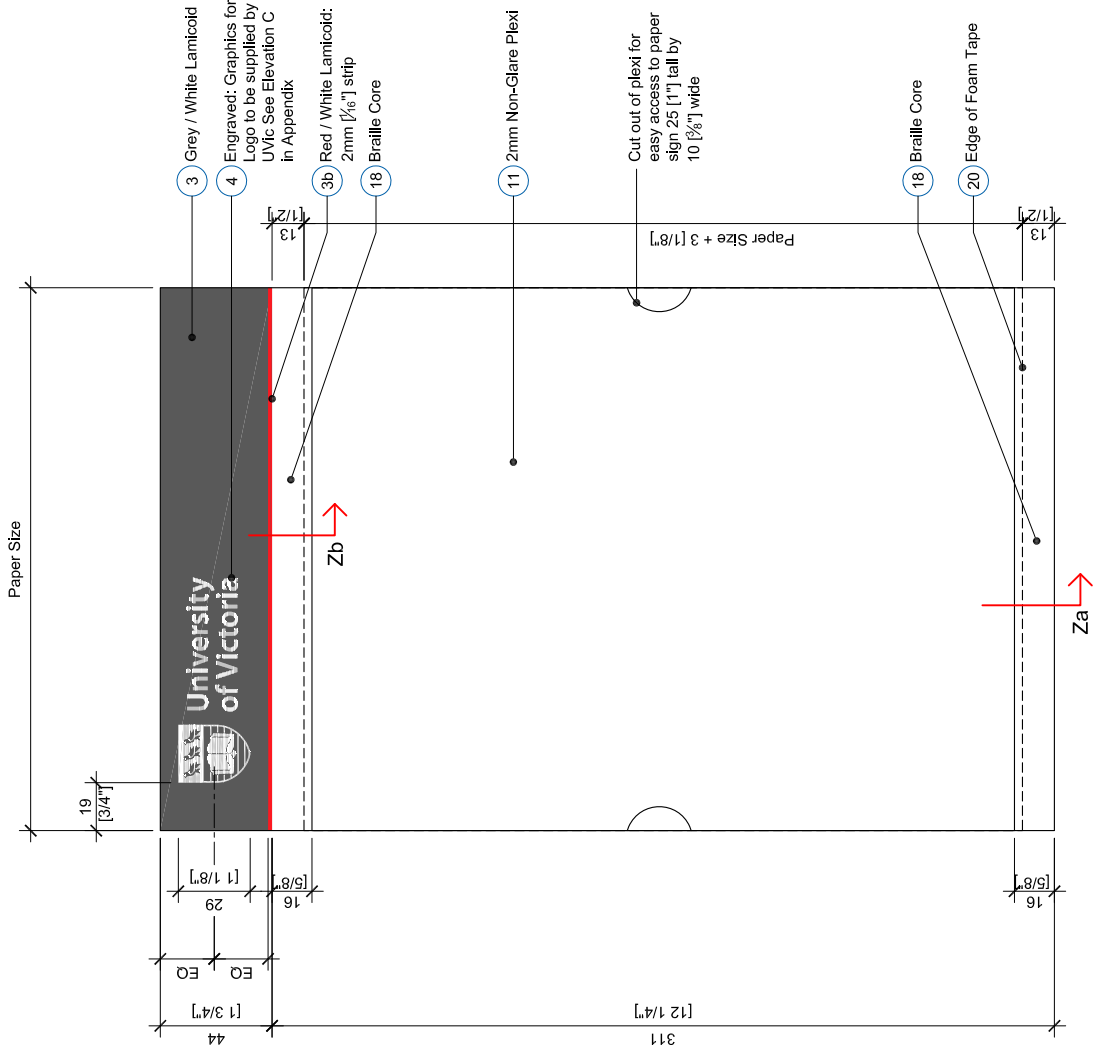

Wall Mounted Sign Holder With Header [N3a]

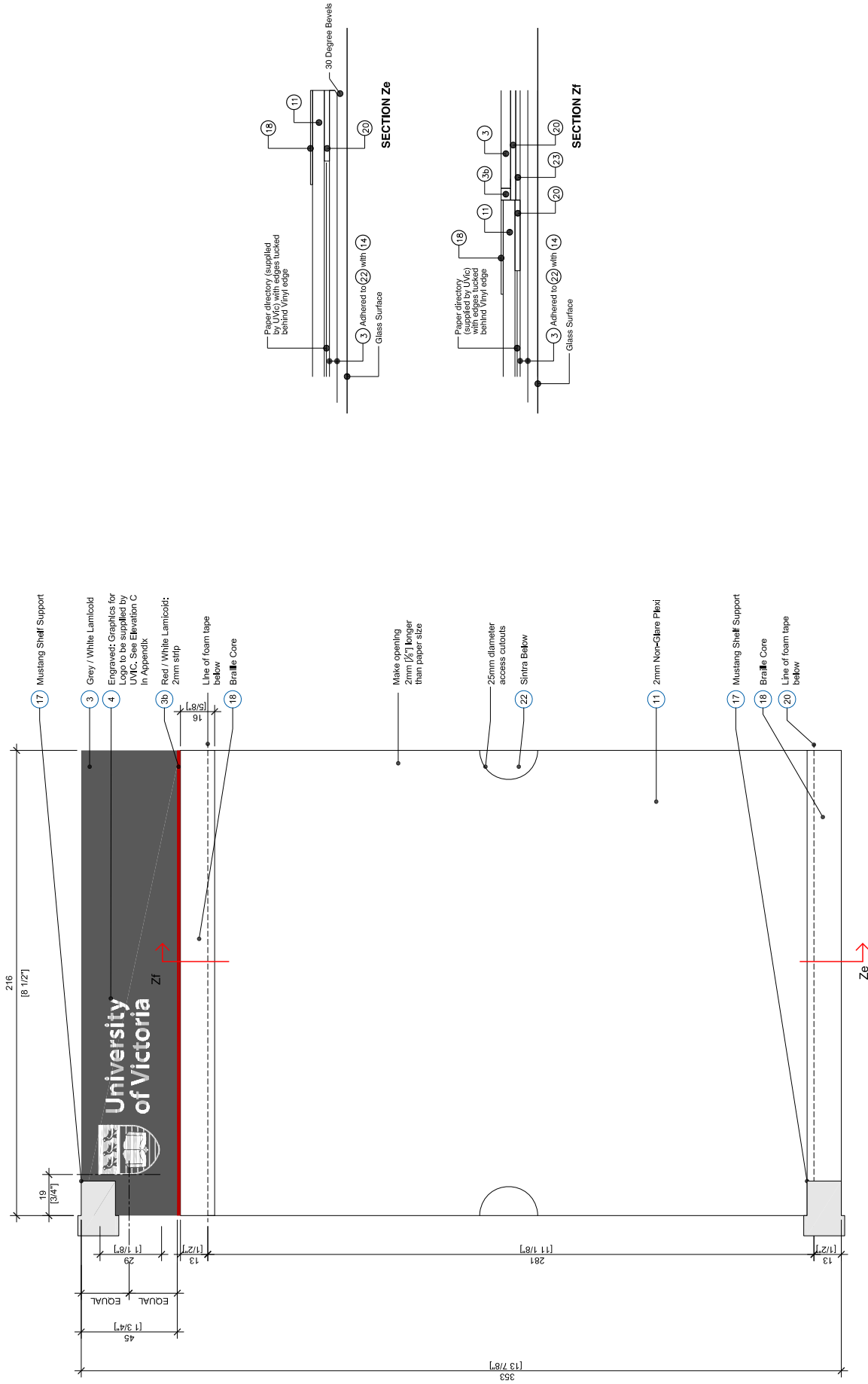

Wall Mounted Sign Holder With Header [N3b]



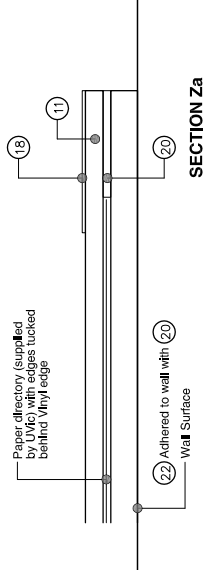
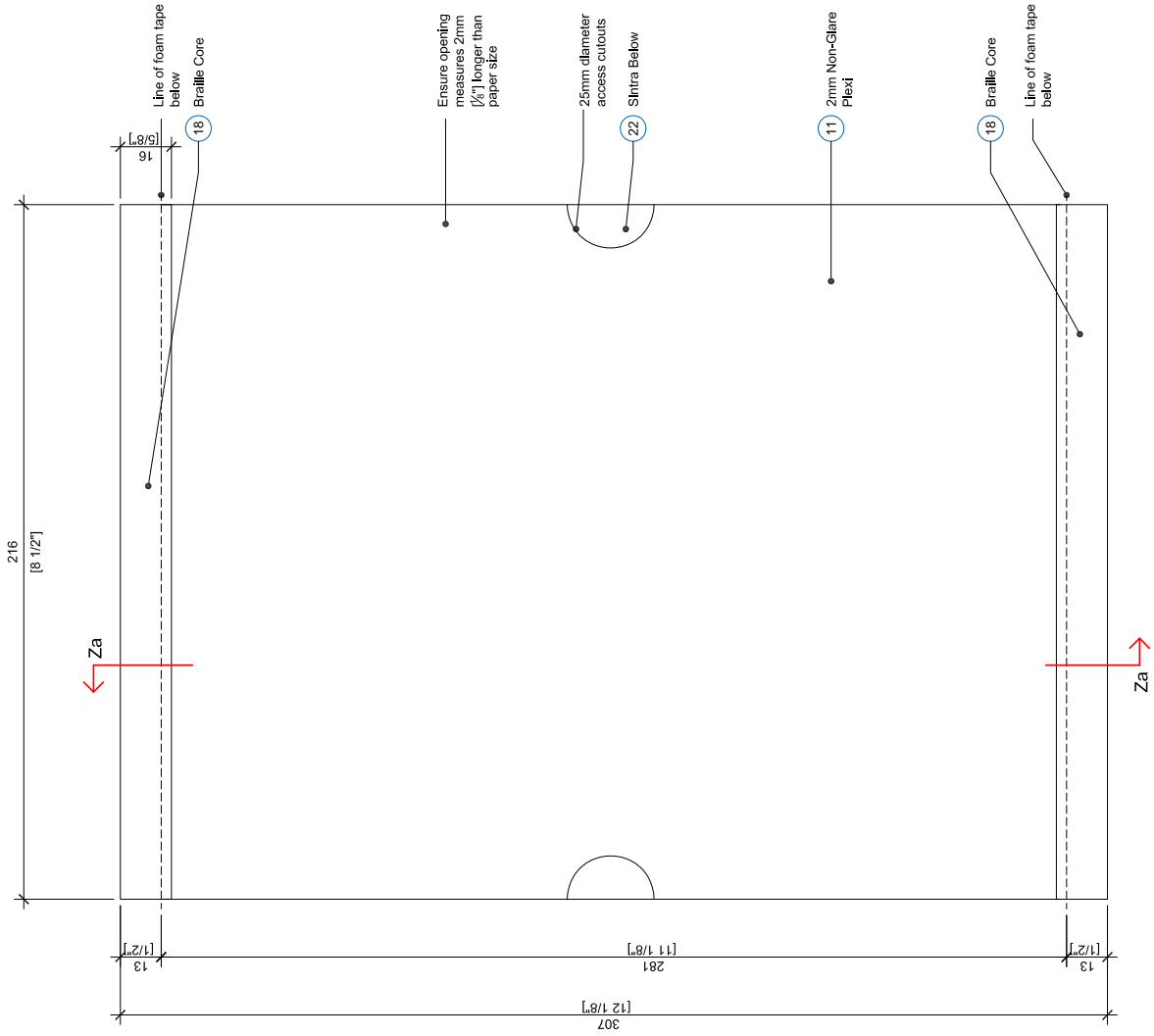

Wall Mounted Sign Holder Without Header [N3c]

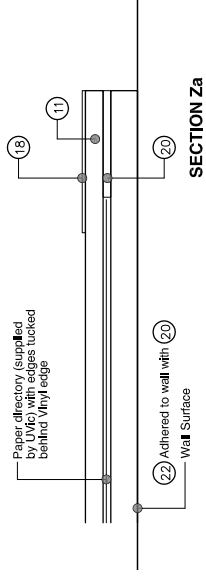
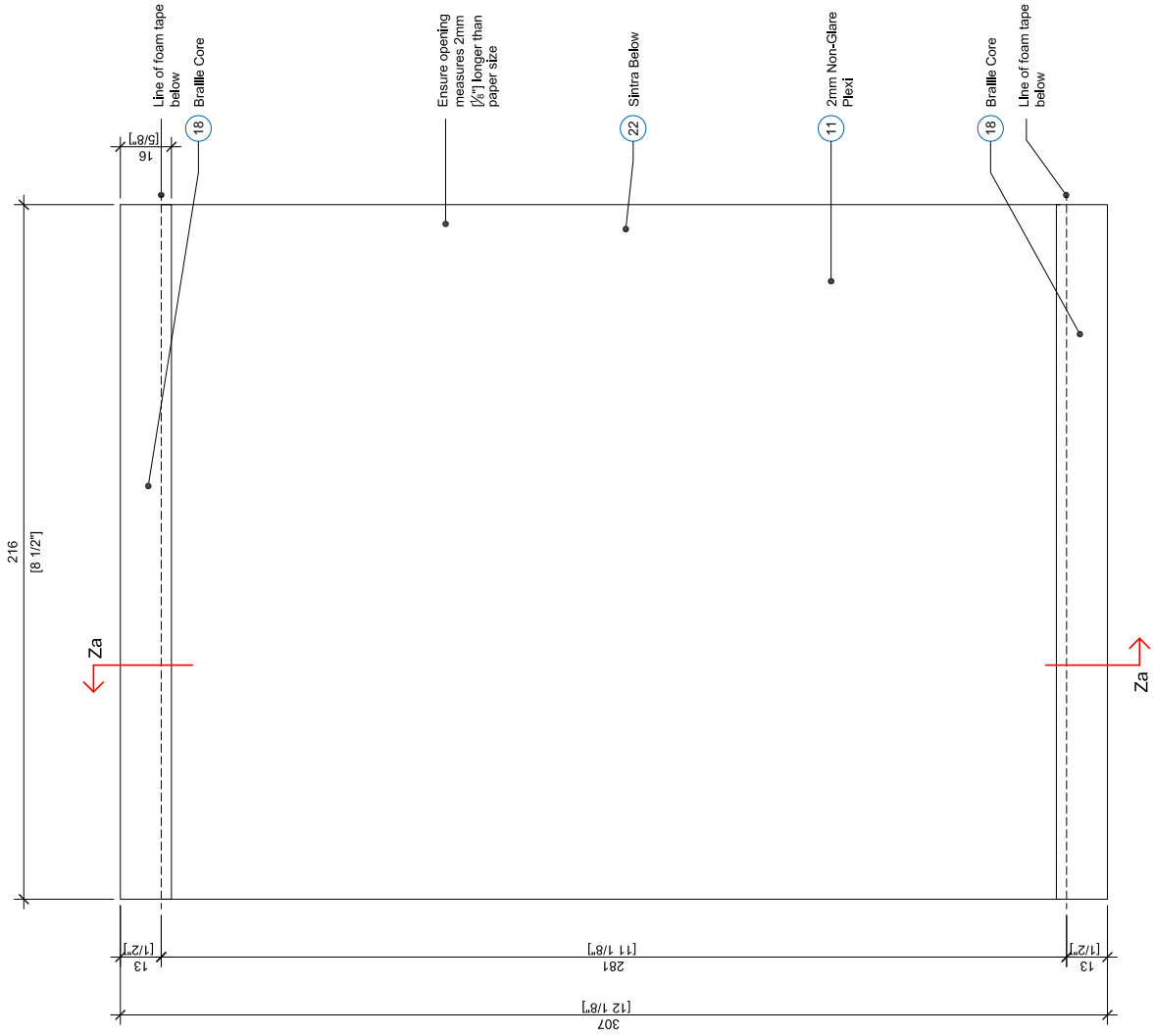

Wall Mounted Sign Holder Without Header [N3d]

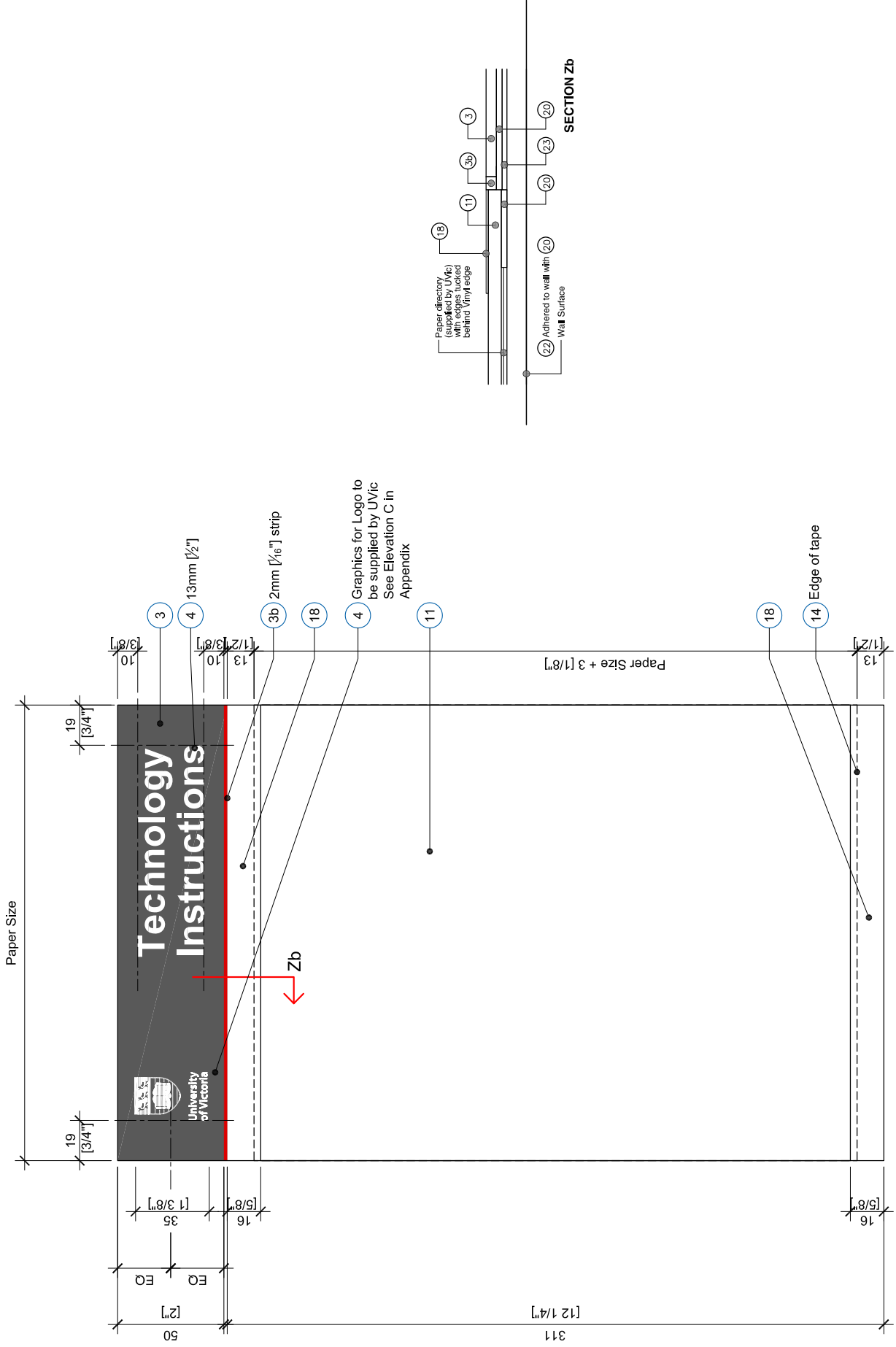

Wall Mounted Sign Holder with Grey Header [N3f]

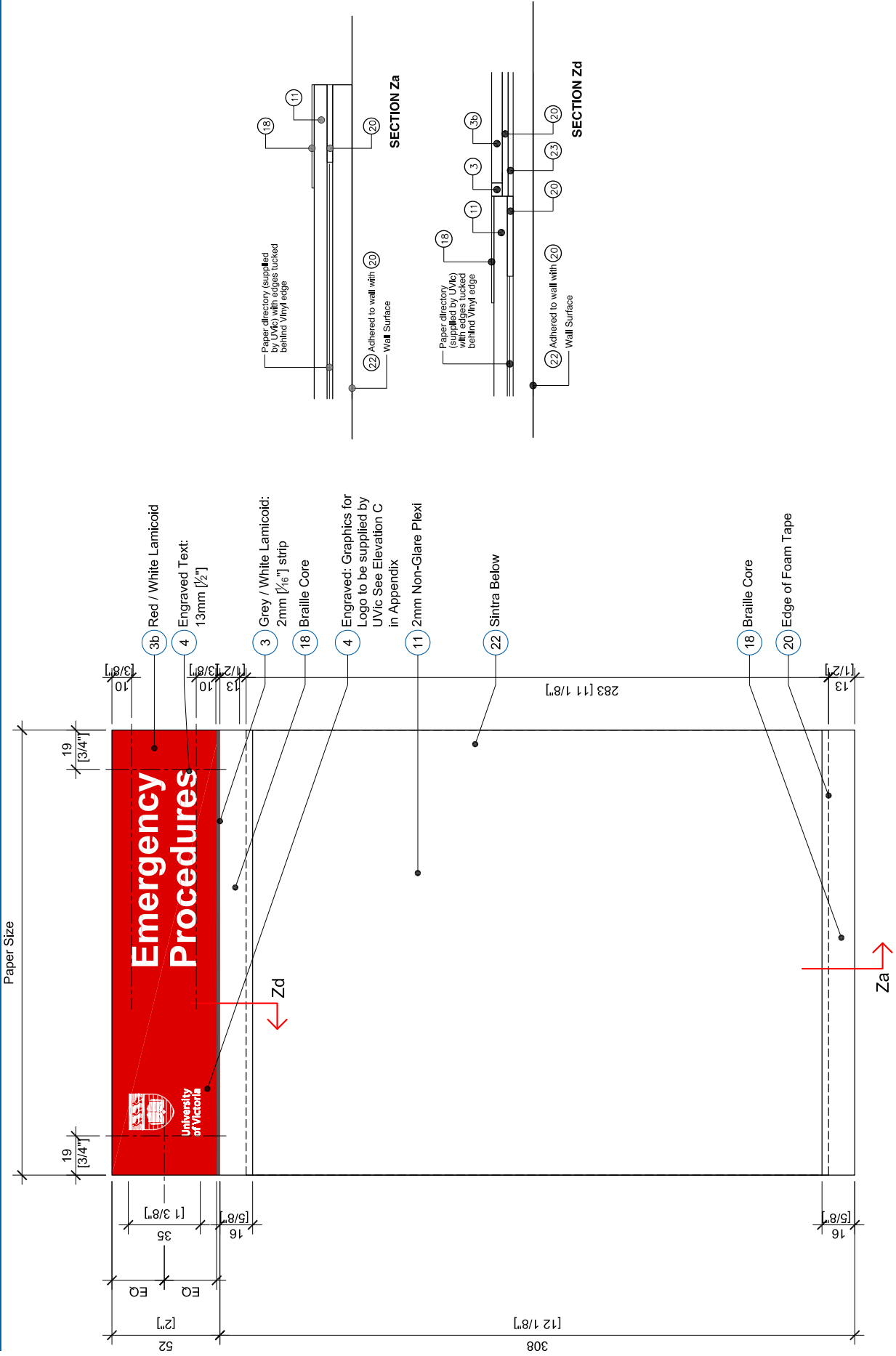

Wall Mounted Sign Holder with Red Header [N3g]

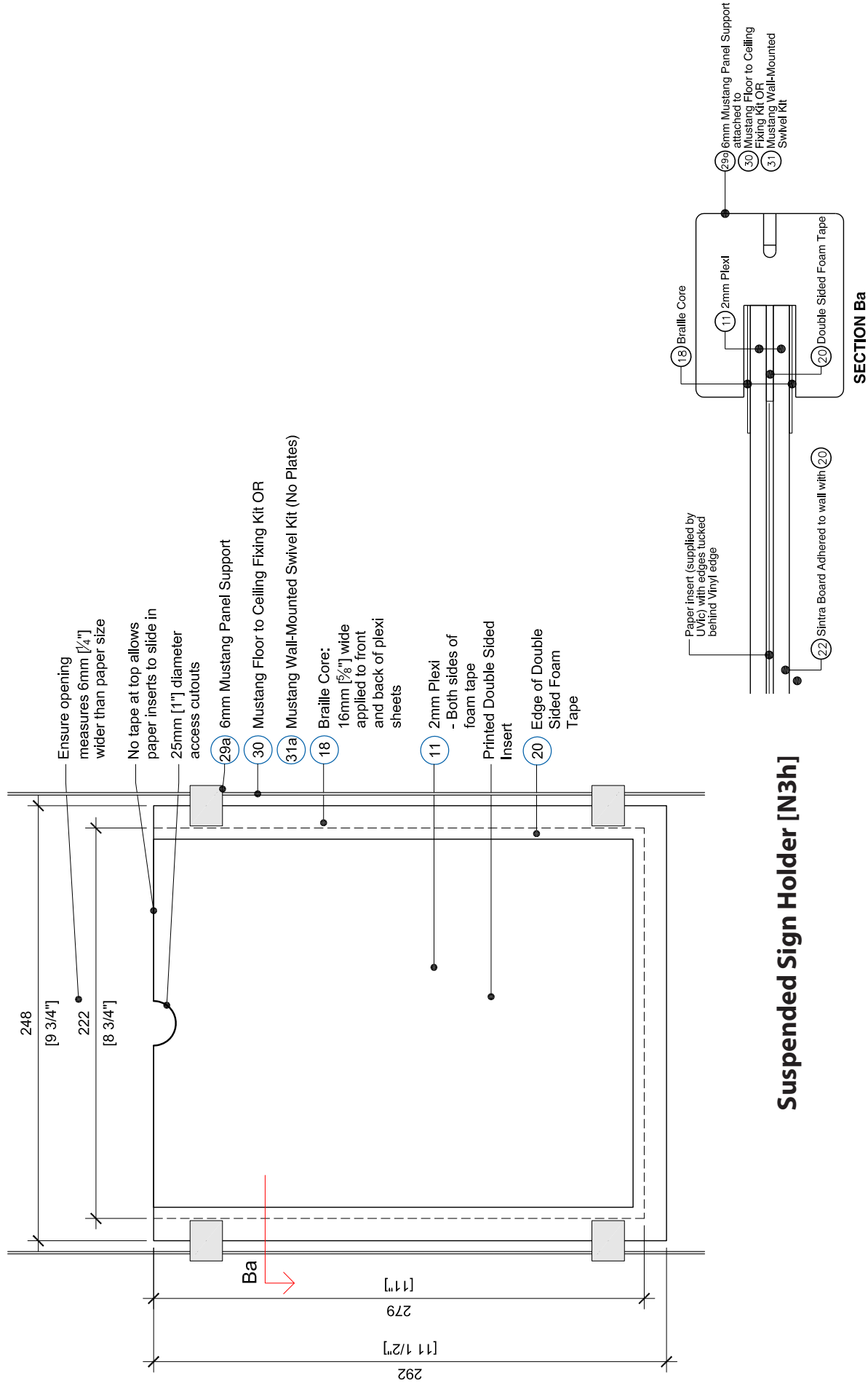

Suspended Sign Holder [N3h]

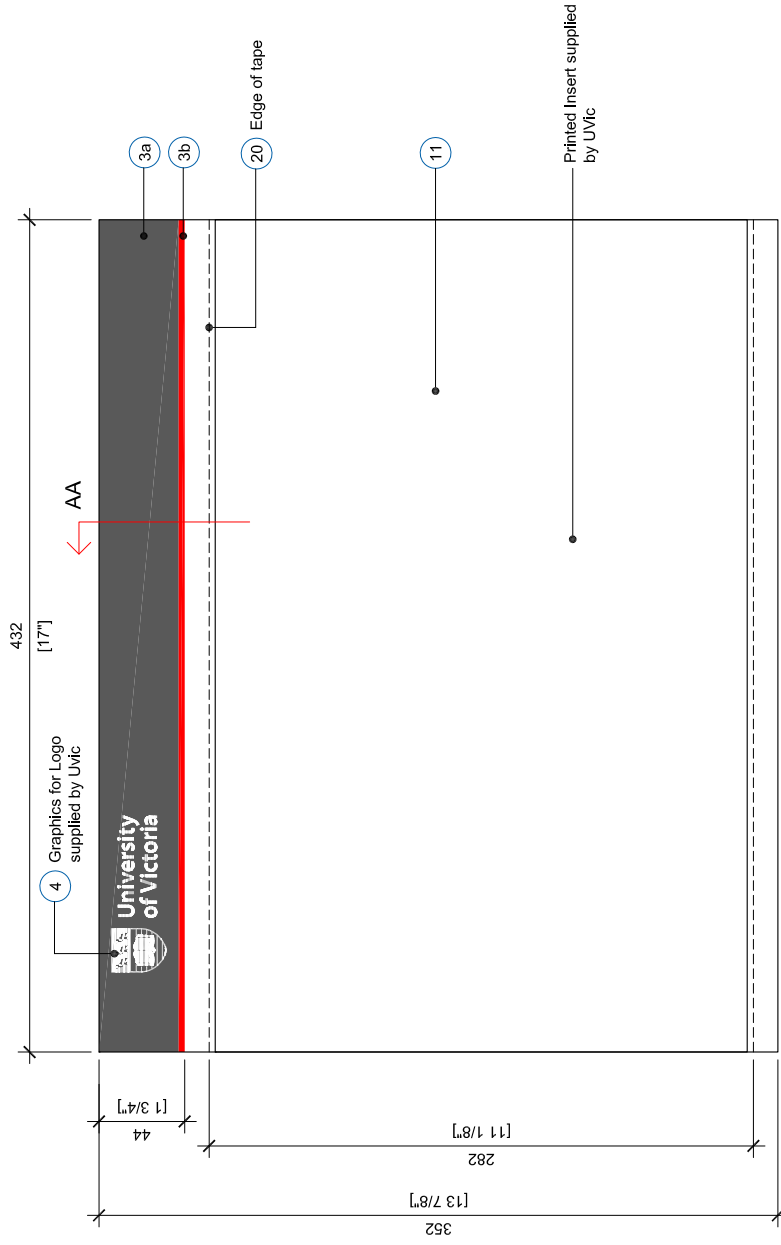

### Lab Information Sign Holder [N4a]

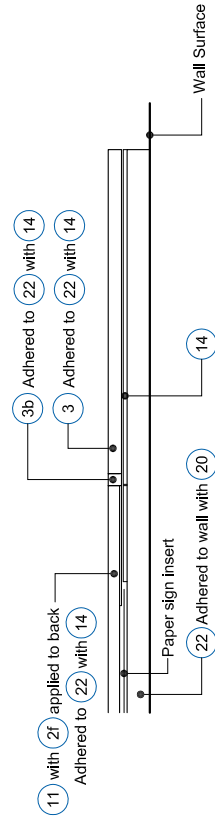

### Section AA

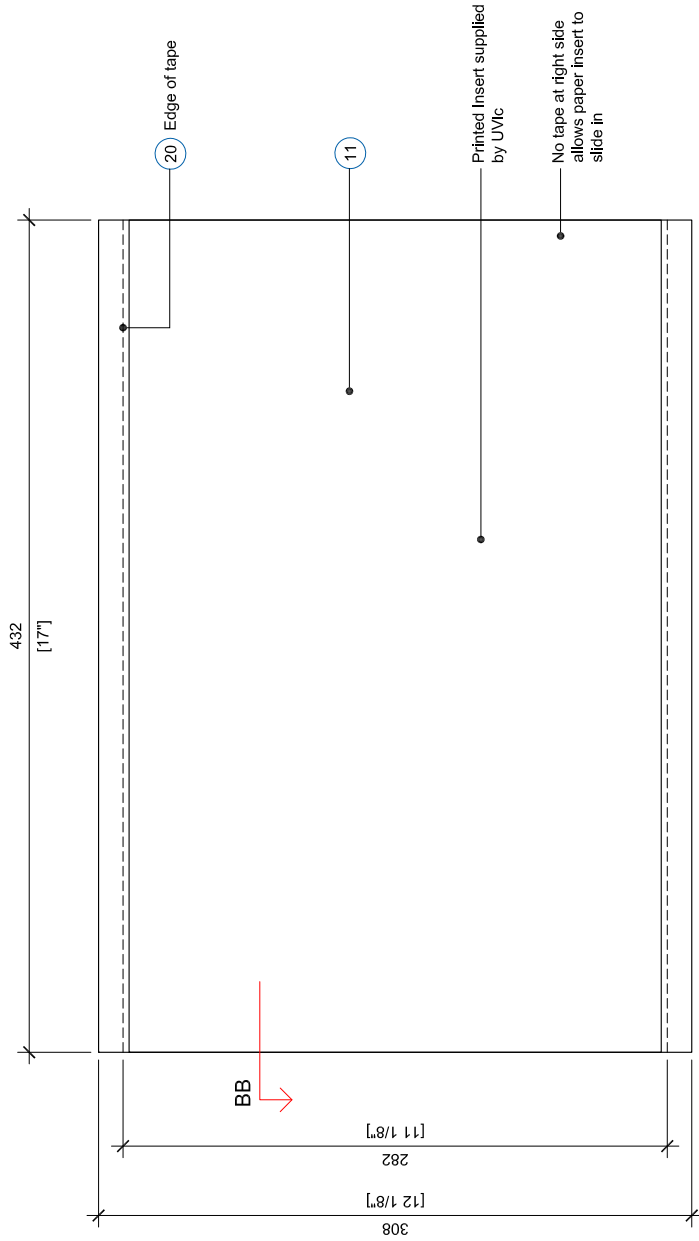

### Secondary Lab Information Sign Holder [N4b]

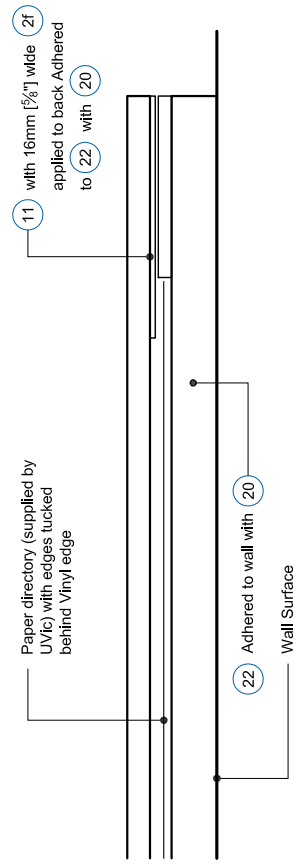

### Section BB

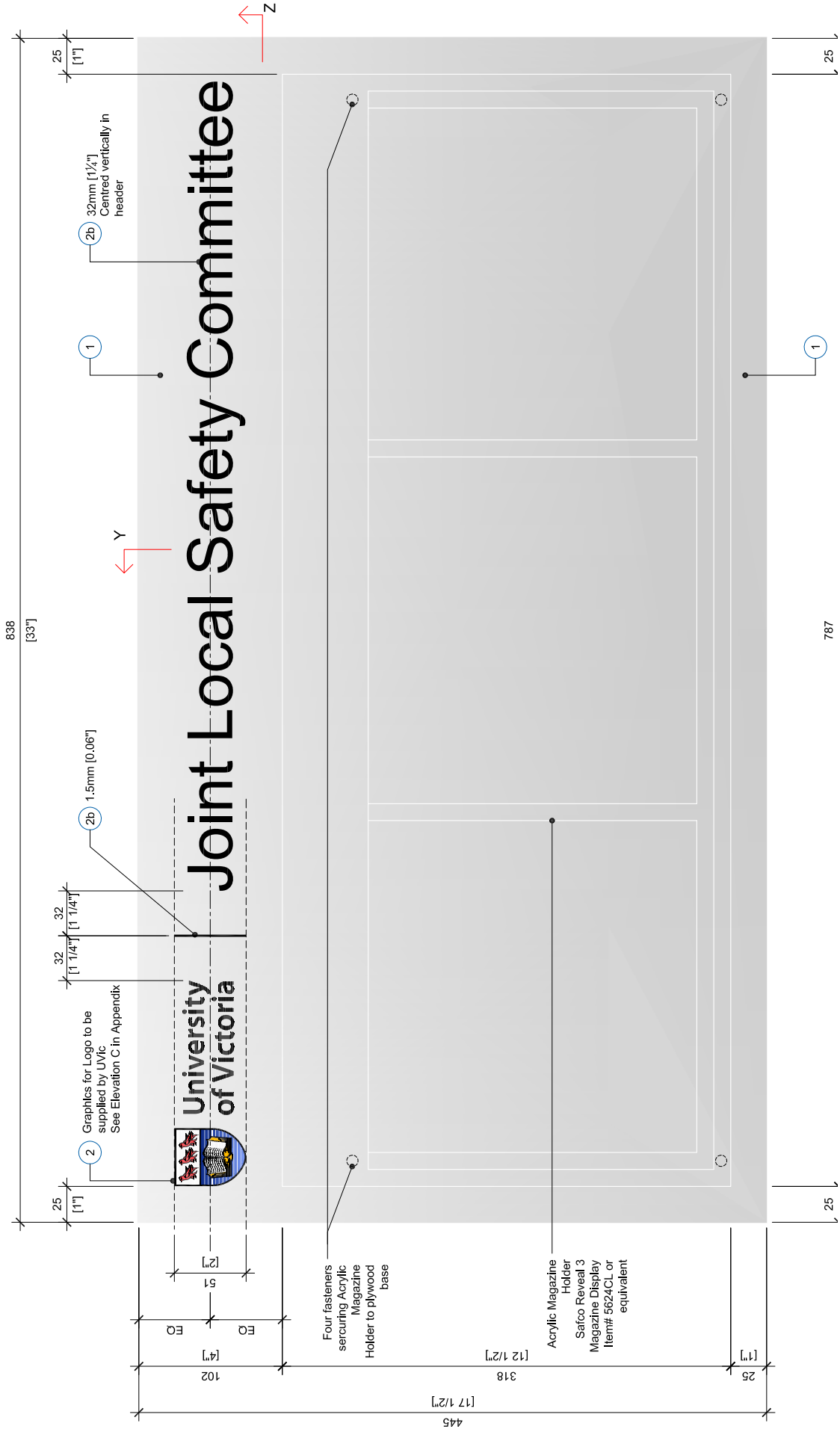

Joint Local Safety Committee Sign [N5]



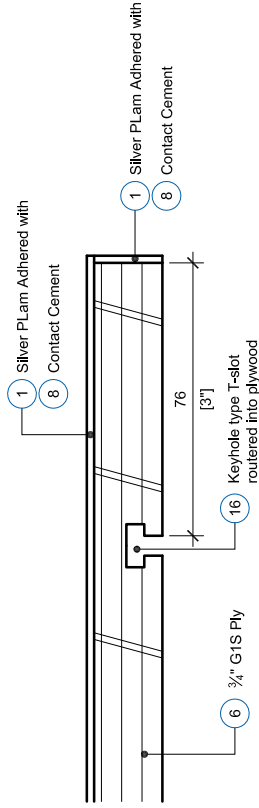

**Section Y**

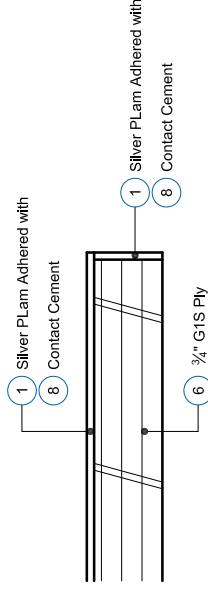

**Section Z**

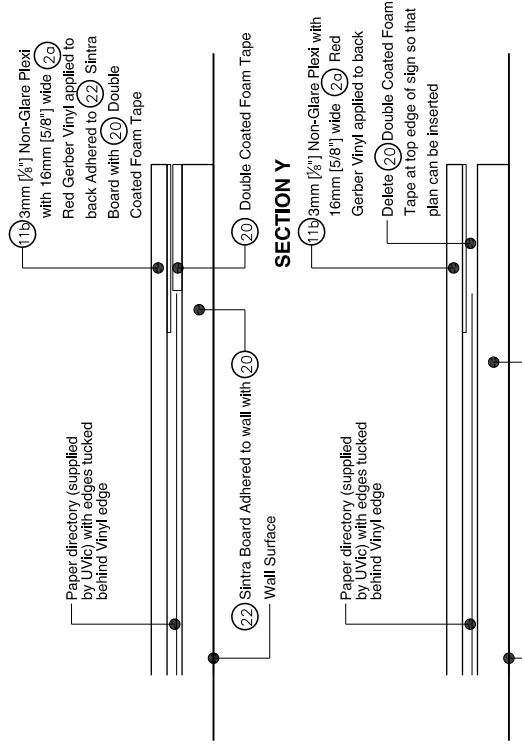
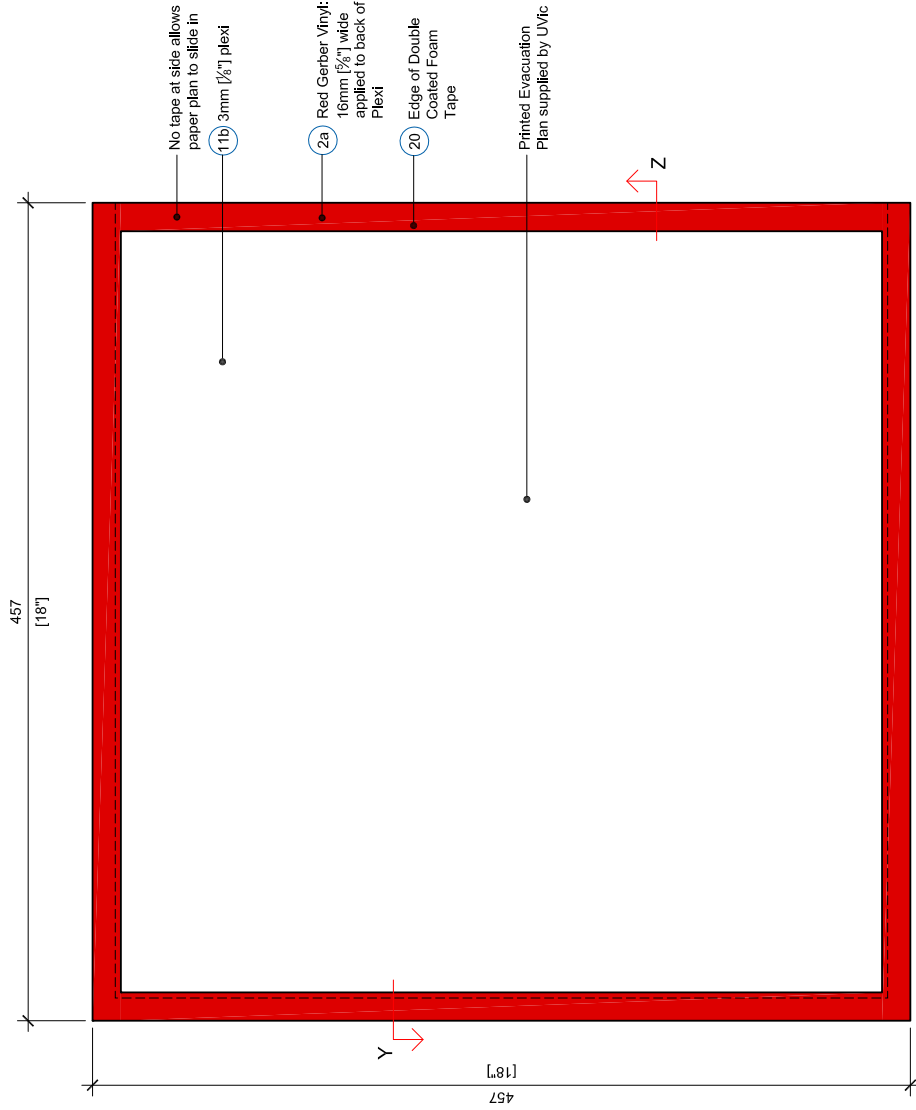

E1

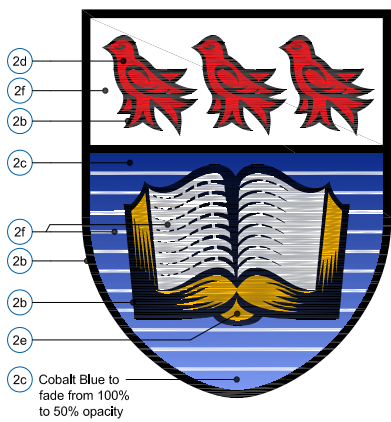

# University of Victoria

ELEVATION C



**Note:**

- University of Victoria logos must maintain proportions and may not be altered, stretched or skewed. A digital copy of the logo will be provided.

ELEVATION D

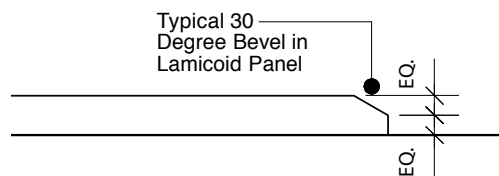

TYPICAL BEVEL DETAIL